

AQUAIR

MARINE AIR CONDITIONING SYSTEMS

Sapphire Series TSVW & TWWS Chillwater Digital Thermostats



Table of Contents

1. Introduction	3
TSVW Main Components	3
TWWS Main Components	4
2. Display Panels for TSVW and TWWS Thermostats	4
TSVW Display Panel Features	5
TWWS Display Panel Features	6
Display Panel Feature Descriptions	7
3. Power Module Box	8
PC Board Features	9
PC Board Jumpers	10
PC Board Fuses	10
PC Board External Wiring Connections	10
4. Operation of Controls	11
5. Programming Mode	12
Programmable Parameter Chart	13
Fault Codes	14
6. Controls Operation Flow Charts & Diagrams	14
Water Valve Operation	15
Heater Operation	15
Auto Fan Speed Operation	16
Fan Speed Process Diagram	17
Cooling Mode Process Diagram	18
Heating Mode Process Diagram	19
Heater Process Diagram	20
Auto Mode Process Diagram	21
Dehumidification Process Diagram	22
7. Wiring Diagrams	23
8. Component Dimensions	27
TSVW	27
TWWS	28

1. Introduction

The Aqua-Air Sapphire TSVW and TWWS Series Chillwater Thermostats has been designed specifically to operate chillwater fan coils. These fan coils will usually have a fan motor(s) and 3 way water regulating valve. They may also be equipped with an integral or remote heating element. All of these components can be regulated by the TSVW and TWWS Thermostats.

The only difference between the TSVW and TWWS digital thermostats are the display heads. The TSVW Thermostat utilizes the TSV-01 Display Head along with a Vimar bezel. The TWWS Thermostat uses the TWWS-01 Display Head which is physically the same size as the older TW-2000 digital thermostats

The TSVW Thermostat is comprised of the following main components:

1. Display Panel (TSV-01)
2. Display Cable (TSWDC-15)
3. Power Module Box (TSVW-02)
4. Room Air Sensor (TW2-SENSOR-07)
5. Water Sensor (TW2-SENSOR-07)

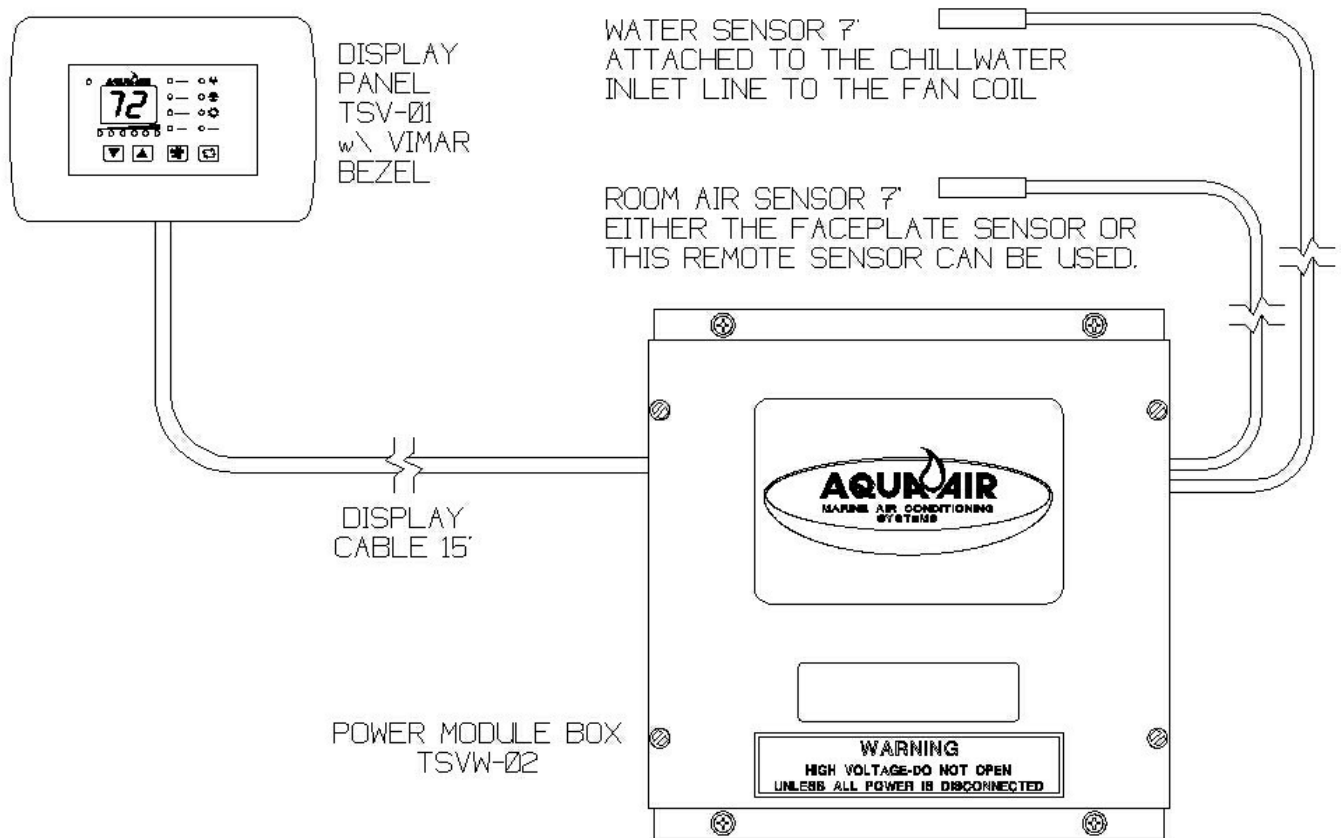

The TWWS Thermostat is comprised of the following main components:

1. Display Panel (TWWS-01)
2. Display Cable (TSWDC-15)
3. Power Module Box (TSVW-02)
4. Room Air Sensor (TW2-SENSOR-07)
5. Water Sensor (TW2-SENSOR-07)

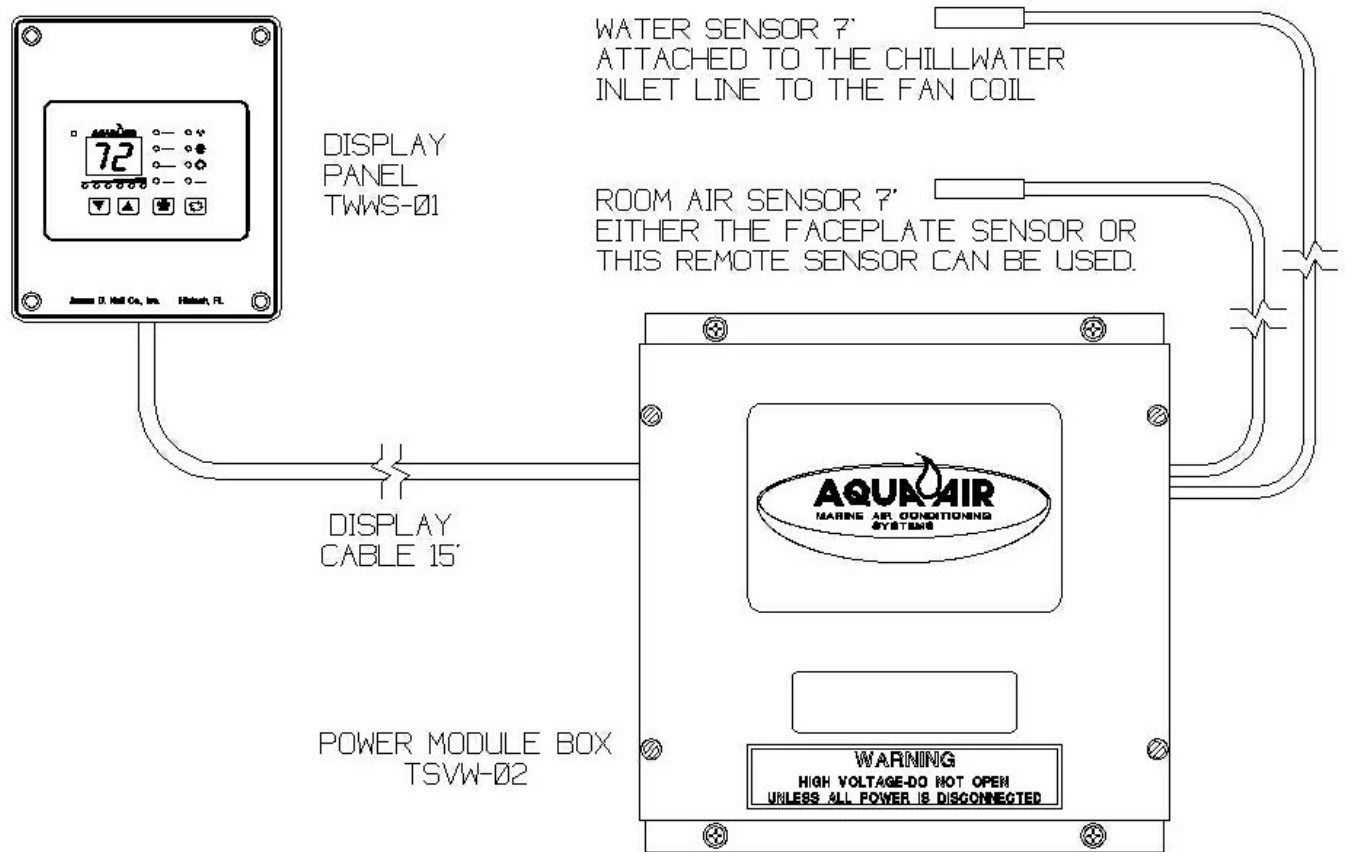

2. Display Panel

The TSV-01 Display Panel is the user interface with the TSVW Thermostat and the TWWS-01 Display Panel is the user interface with the TWWS Thermostat. They allow the user to make all necessary changes to operating modes, temperature settings and fan speed settings. They also allows the user to make changes to a set of Programming Parameters that controls many of the features of the thermostat.

The TSV-01 Display Panel has been designed to use the Vimar Idea Series metal bezels giving you an almost unlimited number of color options to match any decor. The bezel snaps on and off easily and it hides all of the mounting screws for the display panel

On the following two pages are diagrams showing all of the features of the two display panels. Each feature has a number associated with it. Descriptions for each feature begin on the page following the diagrams.

TSVW SAPPHIRE SERIES DIGITAL DISPLAY PANEL

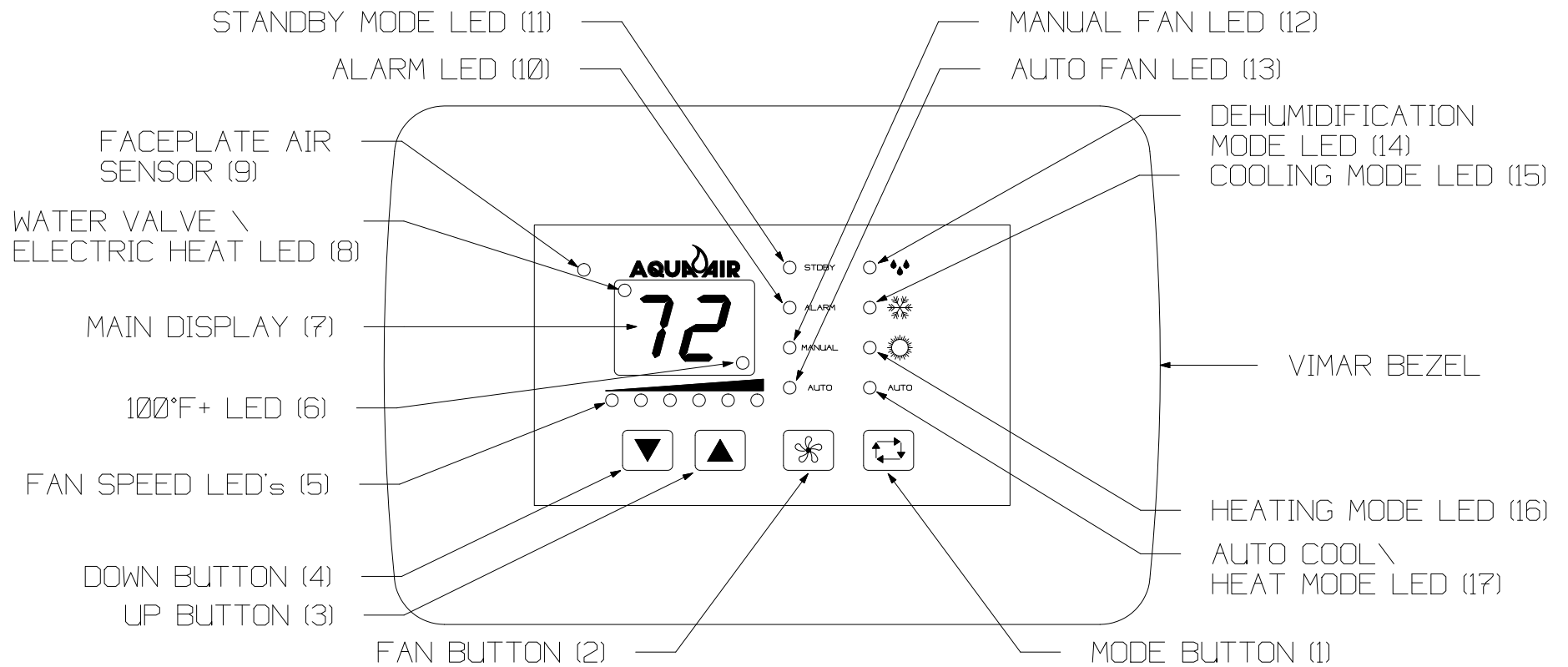

TWWS SAPPHIRE SERIES DIGITAL DISPLAY PANEL

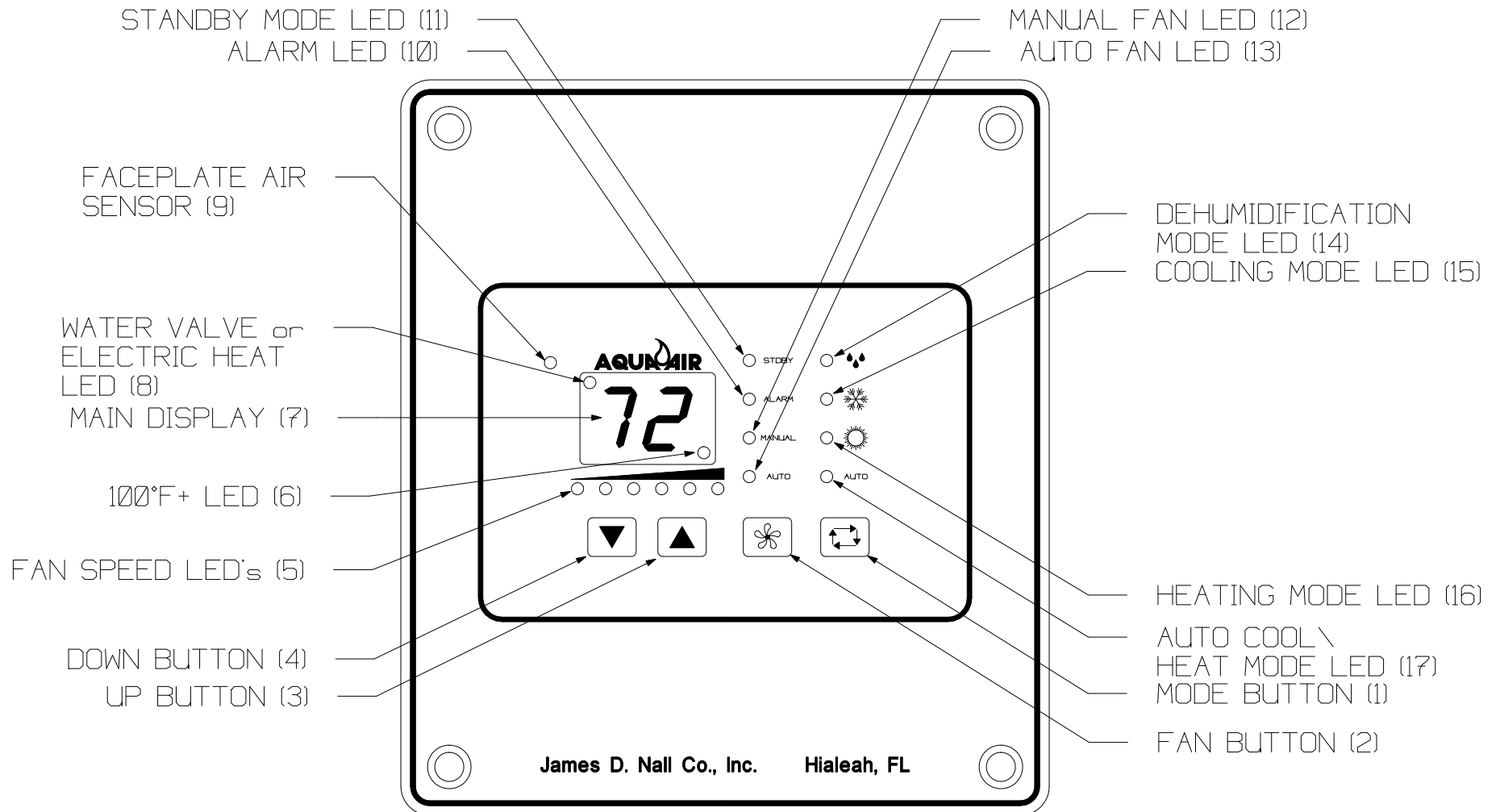

Features of the TSV-01 and TWWS-01 Display Panel are:

1. **MODE BUTTON** - The Mode Button is used to select one of the four operating modes and standby (off) mode. Pressing and releasing the Mode Button will advance you to the next mode. Continue to do this until you have reached the desired mode. The available modes are as follows:

STANDBY Thermostat is OFF, no Cooling or Heating functions are available. The fan can be operated in the Manual mode. Indicated by LED 11.

DEHUMIDIFICATION Thermostat is in the Dehumidification Mode indicated by LED 14.

COOLING Thermostat is in the Cooling Mode only, indicated by LED 15.

HEATING Thermostat is in the Heating Mode only, indicated by LED 16.

AUTO Thermostat is in the Auto Mode where it will automatically choose between Cooling and Heating as the room temperature dictates. This mode is indicated by LED 17.

2. **FAN BUTTON** - The Fan Button is used to select between AUTO and MANUAL Fan Speed Control as indicated by LED's 12 and 13 respectively. To go from AUTO to MANUAL Mode press the Fan Button once. To change Fan Speeds while in MANUAL Mode press the Fan Button once and then the Up or Down Button to increase or decrease, respectively, the Fan Speed. To switch from MANUAL to AUTO Mode press the Fan Button twice

3. **UP BUTTON** - The Up Button is used to increase values for set points, fan speeds and programmable parameters. During normal operation, momentarily pressing the Up Button will display the Set Point. Continued pressing of the Up Button will increase the Set Point

4. **DOWN BUTTON** - The Down Button is used to decrease values for set points, fan speeds and programmable parameters. During normal operation, momentarily pressing the Down Button will display the Set Point. Continued pressing of the Down Button will decrease the Set Point.

To view the Chillwater Inlet Temperature sensed by the TSVW Water Sensor.

1. Press and HOLD the Down Button (4)
2. Press and RELEASE the Up Button (3)

This will display the temperature sensed by the TSVW Water Sensor.

5. **FAN SPEED LED's** - These six LED's indicate the current Fan Speed 1-6. Low Speed (#1) is the left most LED and High Speed (#6) is indicated by the LED on the far right.

6. 100°F+ LED - Indicates that the actual temperature displayed is in excess of 100° F. Add the value displayed to 100 to get the actual temperature. If the 100°F LED is lit and the display shows 10 then the actual temperature would be 110°F.
7. MAIN DISPLAY - This is a 2 digit, 7 segment LED display. Normally the current room temperature is displayed. It can also display the Set Point, Water Temperature, Programmable Parameters and Alarm codes.
8. WATER VALVE / ELECTRIC HEAT LED - This LED indicates if the Water Valve output has been turned on (in either the Cooling or Heating mode) or, if an Electric Heater is being used and the control has been programmed for it (Programmable Parameter A5 = EL), it will indicate when the Electric Heater output is energized.
9. FACEPLATE AIR SENSOR - The TSVW can use either this Faceplate Air Sensor to sense the room temperature or the Air Sensor that is plugged into the Power Module PC Board. This is selected by Programmable Parameter B1. If the Faceplate Sensor is used it is not necessary to have the Air Sensor plugged into the PC Board.
10. ALARM LED - Indicates that the control is in a fault condition.
11. STANDBY MODE LED - Indicates that the control is in the Standby Mode. All Cooling and Heating functions are turned off. If the fan is in the Auto Mode then it will be turned off. If the Fan is in the Manual Mode then the Fan will still operate at the last fan speed selected.
12. MANUAL FAN LED - Indicates the Fan Speed is in the Manual Speed Selection Mode
13. AUTO FAN LED - Indicates the Fan Speed is in the Automatic Speed Selection Mode
14. DEHUMIDIFICATION MODE LED - Indicates that the control is in the Dehumidification Mode
15. COOLING MODE LED - Indicates the control is in the Cooling Mode
16. HEATING MODE LED - Indicates the control is in the Heating Mode
17. AUTO COOL/HEAT MODE LED - Indicates the control is in the Automatic Cooling or Heating Mode. In this mode the control will automatically select, based on the room temperature and the set point, whether the control is operating in the Cooling or Heating Mode.

3. Power Module Box

The Power Module Box is comprised of the Main Power PC Board enclosed inside of an aluminum enclosure. The PC Board's main features are shown on the following page.

TSVW POWER MODULE P.C. BOARD TWS-PCBOARD

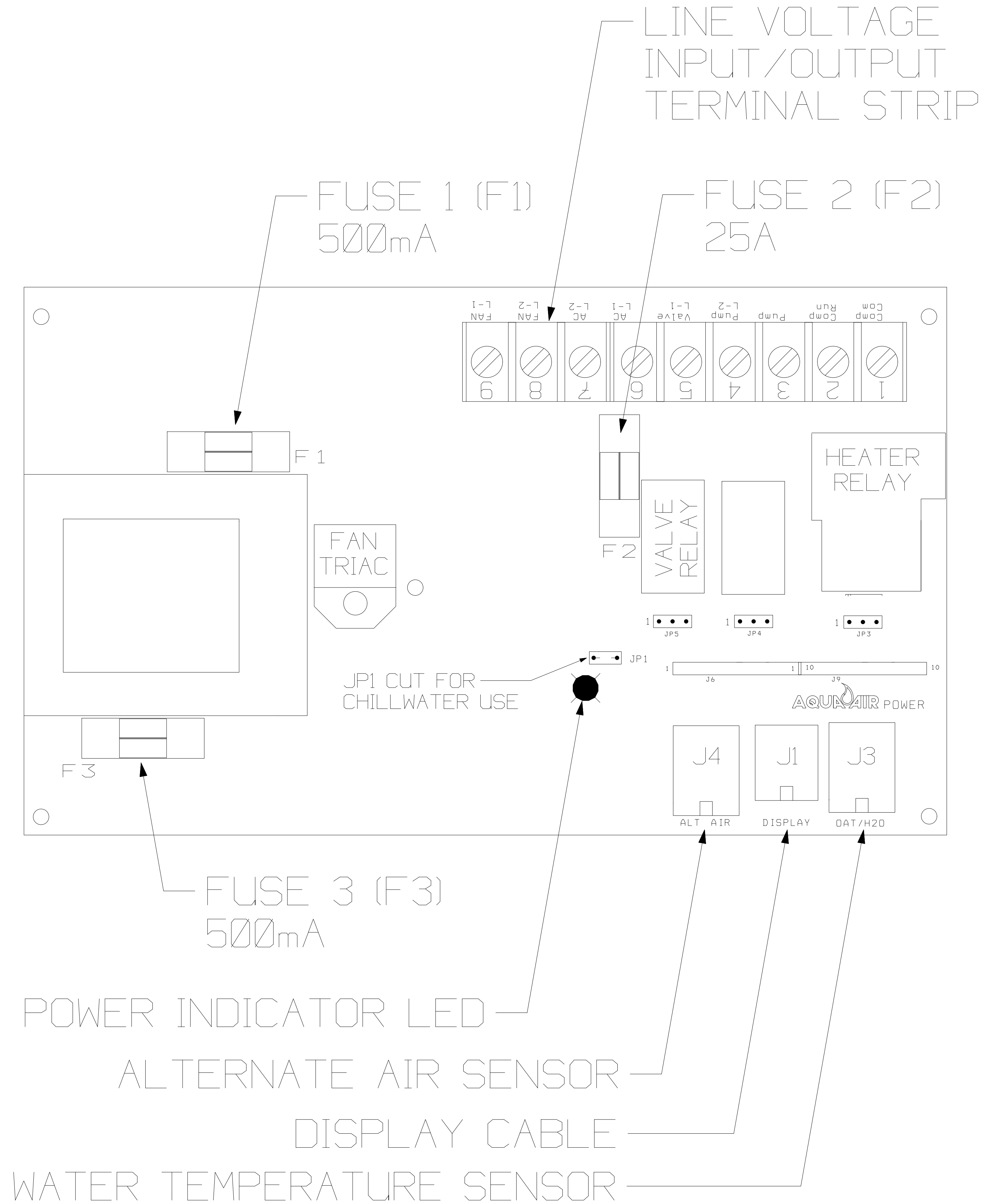

POWER MODULE PC BOARD JUMPERS				
Jumper	Description	Type	Specification	Notes
JP1	Chillwater / Direct Expansion Selection	Wire	C/W: Jumper Cut D/X: Jumper Not Cut	Do not cut with power applied to board.
JP3	Heater Relay Test	3 pos. pin	Install jumper in positions 1 & 2 to energize the heater	
JP5	Water Valve Relay Test	3 pos. pin	Install jumper in positions 1 & 2 to energize the water valve	

POWER MODULE PC BOARD FUSES			
Fuse	Description	Fuse Amperage Rating	Fuse Size Part Number
F1	Protects against a line voltage short circuit on the primary side of the transformer TX	500 mA (1/2 A)	5mm x 20mm TWS-PCBFUSE1
F2	Protects against a short circuit on the Heater or Water Valve Circuits	20 A	5mm x 20mm TWS-PCBFUSE1
F3	Protects against a control circuit short circuit on the secondary side of the transformer TX	500 mA (1/2 A)	5mm x 20mm TWS-PCBFUSE1

**Basic External Wiring Connections to the
TSVW & TWWS PC Board Located in the Power Module Box**

PC BOARD TERMINAL STRIP

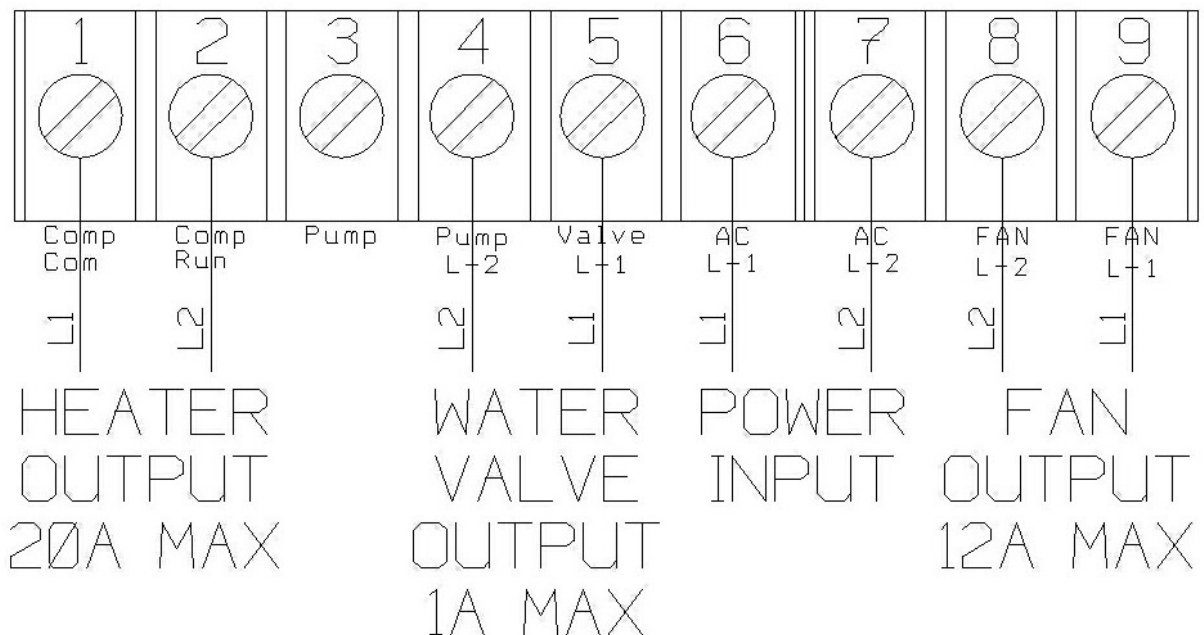

4. Chillwater Operation

Below are the steps necessary for the basic operation of the control.

Entering the Cooling Mode

Press and release the Mode Button (1) until the Cooling Mode LED (15) is lit.

Entering the Heating Mode

Press and release the Mode Button (1) until the Heating Mode LED (16) is lit.

Automatic (Auto) Cool / Heat Mode

Press and release the Mode Button (1) until the Auto LED (17) is lit

Entering the Dehumidification Mode

Press and release the Mode Button (1) until the Dehumidification Mode LED (14) is lit.

Turn the Control OFF (Standby Mode)

Press and release the Mode Button (1) until the Standby Mode LED (11) is lit.

View the Set Point Temperature

Press and release either the Up Button (3) or the Down Button (4).

Increasing the Set Point Temperature

Press and release the Up Button (3) until you reach the desired temperature

Decreasing the Set Point Temperature

Press and release the Down Button (4) until you reach the desired temperature

Putting the Fan Mode into Manual

Press and release the Fan Button (2) until the Manual Fan LED (12) is lit

Increasing the Fan Speed in the Manual Fan Mode

Press and release the Fan Button (2) and then press and release the Up Button (3) until you reach the desired speed as indicated by the Fan Speed LED's (5).

Decreasing the Fan Speed in the Manual Fan Mode

Press and release the Fan Button (2) and then press and release the Down Button (4) until you reach the desired speed as indicated by the Fan Speed LED's (5).

Putting the Fan Mode into Auto

Press and release the Fan Button (2) twice

Displaying the Chillwater Inlet Temperature at the Fan Coil

Press and hold the Down Button (4) then press and release the Up Button (3)

Changing the Fan Speeds in the Standby Mode

Press and release the Up Button (3) or the Down Button (4) until the desired speed is reached. To turn the fan off in the Standby Mode press the Down Button (4) until all of the Fan Speed LED's are off.

5. Entering the Programming Mode

There are currently 14 different programmable parameters in the TSVW Thermostat. All of these parameters can be changed from the Display Panel with some simple keystrokes.

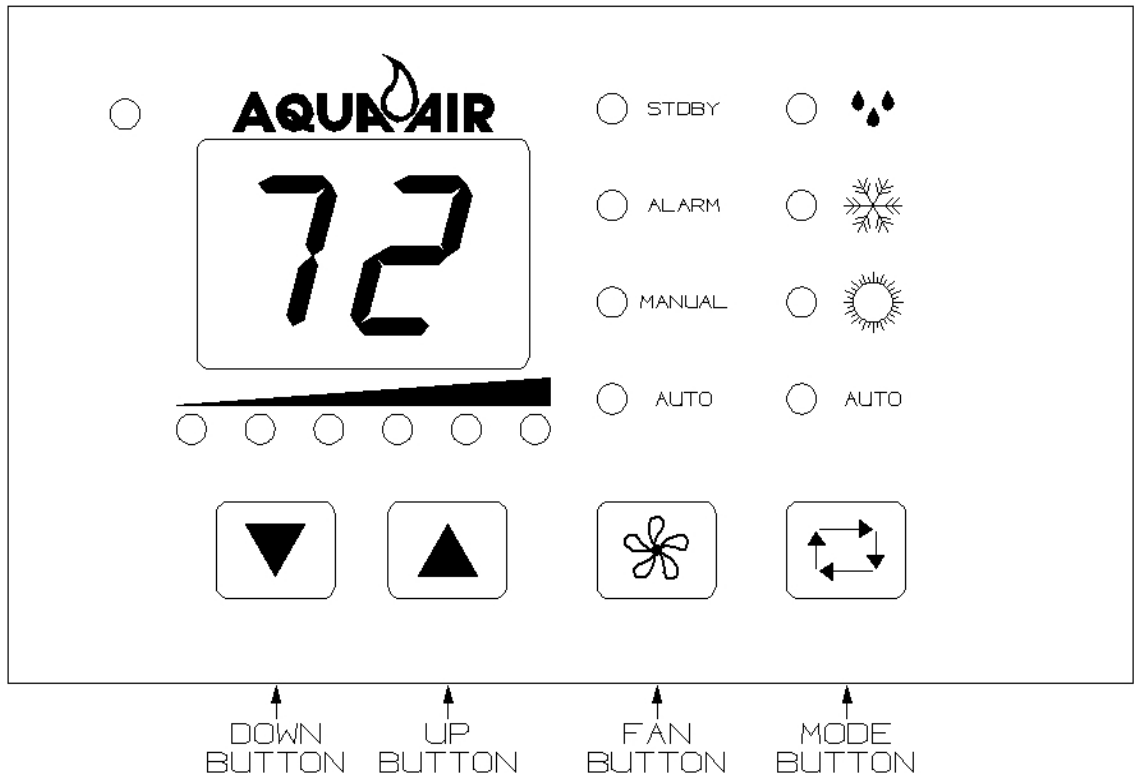

The Program Mode can ONLY be entered while the control is in the Standby Mode

To Program the TSVW Control:

1. Press the Mode Button until the control is in the Standby Mode which is indicated by the Standby Mode LED (11)
2. Press the Up Button and the Down Button at the SAME time. The first Programmable Parameter code "P1" will appear in the window for 2 seconds and then the P1 setting that is currently stored in the control will appear.
3. To change the parameter setting press and release the Up or Down Buttons.
4. The Fan Button advances you to the next parameter. Advancing to the next parameter SAVES the previous parameter setting. If you do not advance to the next parameter the setting WILL NOT BE SAVED unless you press the Mode Button to exit the Programming Mode (see 5 below).
5. Pressing the Mode Button exits the Programming Mode. Any changes made to any of the parameter settings will be saved.
6. If you do not press any buttons for 30 seconds the control will automatically exit from the Program Mode. The last parameter change will NOT BE SAVED.

Programmable Parameters			
Parameter Number	Description	Default	Range
P1*	High Fan Speed Limit (% of input voltage)	100 "00."	56 - 100 (100 = 00.)
P2* **	Low Fan Speed Limit (% of input voltage)	50	30 - 55
P3	Unused-Reserved for future applications	N/A	N/A
P4	Temperature Sensor Calibration	0	-10° to +10° F
P5 to P8	Unused-Reserved for future applications	N/A	N/A
P9	Display LED Brightness Control	13	4 = minimum 13 = maximum
A1	Displays °F or °C	°F	°F / °C
A2	Unused-Reserved for future applications	N/A	N/A
A3	Reverse Fan Speed in Heating Mode	rE	No = Normal rE = Reverse
A4	Continuous Fan Operation or Cycling on Demand	Co	CY = Cycle Co = Continuous
A5	Hot Water Heating or Electric Element Heat	Of	Of = Hot Water EL = Electric Heat
A6	Fan Motor Type, Shaded Pole or Split Capacitor	SP	SP = Shaded Pole SC = Split Capacitor
A7	Reset Memorized Programming Defaults	nO	nO = Normal Rs = Reset Default
A8	Force Water Valve Open for 4 Hours to Bleed the Air from the Chillwater Loop	no	no = Normal Operation oP = Open
A9	Ambient Air to Chilled Water Temperature Differential	15° F	5° to 25° F
b1	Air Temperature Sensed from the Display Panel or the Air Sensor connected to the PC Board	on	on = PC Board of = Display Panel
b2	Delay Before Fan Turns Off	30s	30 - 199 seconds

* P1 and P2 values are expressed as a percentage of the input voltage. If the setting for P1 is 90 then the maximum voltage output at high fan speed (speed 6) will be approximately 90% of the input voltage. As you are changing the settings in P1 and P2 the fan will operate and change according to the settings you are entering.

** If Electric Heat is selected (A5 = EL) then P2 must NOT be set lower than 50 and parameter b2 must be set to a minimum of 60 seconds.

FAULT CODES	
Code	Description
E1	Display cable damaged. Check to see if the cable has been cut or otherwise damaged.
LA	Low Voltage Input to Power Module Box. Check your incoming voltage to the Power Module Box and verify that it is within +/-10% of the rated voltage
AA	Air Sensor Failure or Disconnected. If you get this error code and you intend to use the air sensor on the Display Panel change Parameter b1 to "of".

6. Control Operation Flow Charts and Diagrams

On the following pages are flow charts and graphic representations of how the control operates the water valve, fan and heater (if so equipped) in each of the 4 operating modes. Some of the abbreviations are as follows:

TERM	Definition
Abs	Absolute Value. The Absolute Value of 5 is 5. The Absolute Value of (-3) is 3. The Absolute Value of an equation that returns a negative number is always a positive number. Therefore Abs (3-8) = 5
DELTA	Difference between two values. As used in this manual it is the difference between two temperatures
Hysteresis	The lag between making a change, such as increasing or decreasing temperature, and the response or effect of that change. It typically refers to turn-on and turn-off points. For example, if a thermostat set for 70 degrees turns on when the temperature reaches 68 and turns off at 72, the hysteresis is the range from 68 to 72.
LED	Light Emitting Diode. These are all of the lights on the display panel. The two 7 segment numerical displays are each made up of 7 individual diodes.
Tair	Air Temperature as sensed by either the Display Panel or Room Air Sensor
Twater	Water Temperature as sensed by the Water Sensor
To	Ambient air to chillwater differential. This is set in P18.
Tset	Set Temperature of the thermostat

WATER VALVE & HEATER OPERATION

COOLING MODE - WATER VALVE

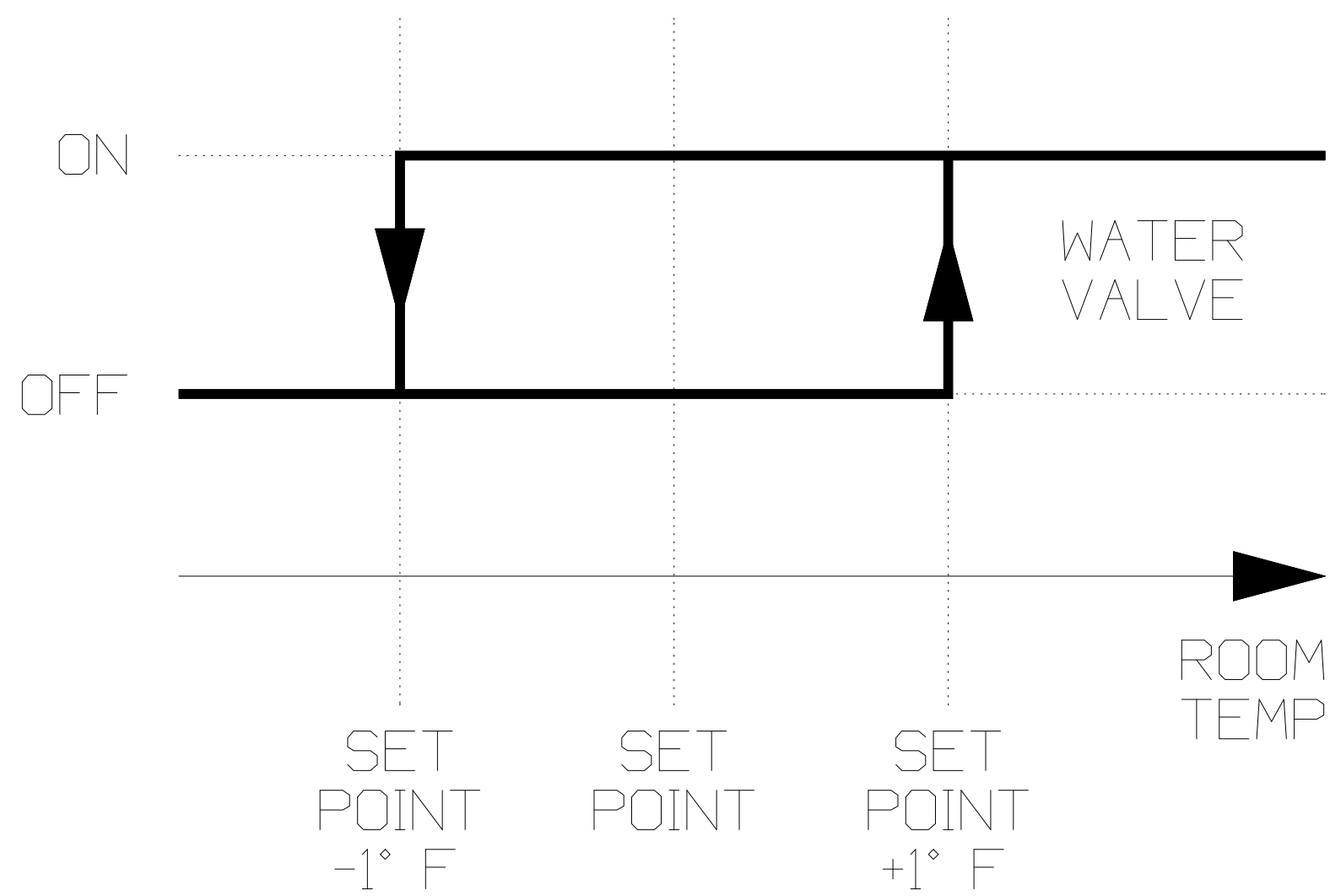

HEATING MODE - WATER VALVE PARAMETER A5 = HOT WATER ONLY (Of)

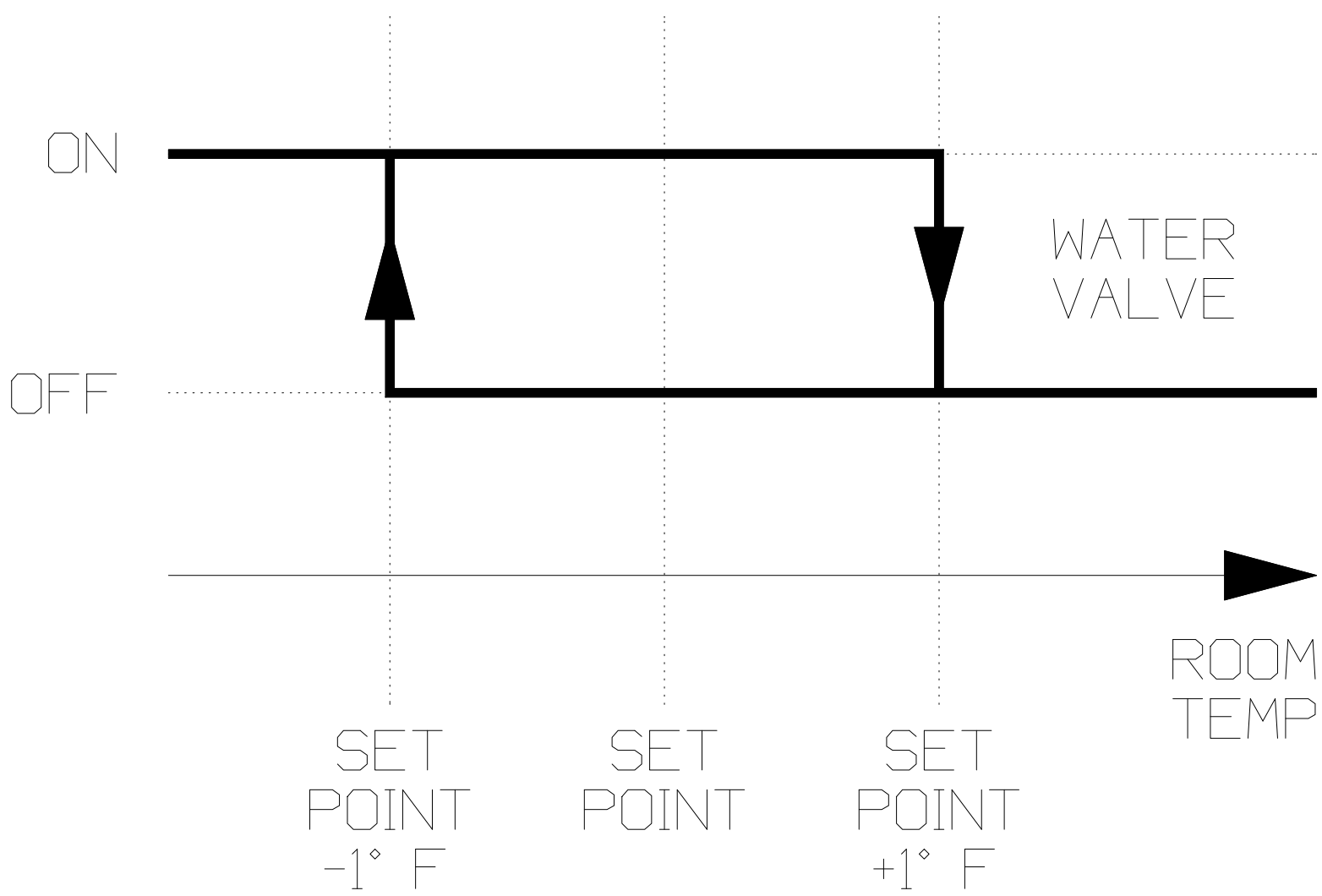

HEATING MODE - HEATING ELEMENT PARAMETER A5 = ELECTRIC HEAT (EL)

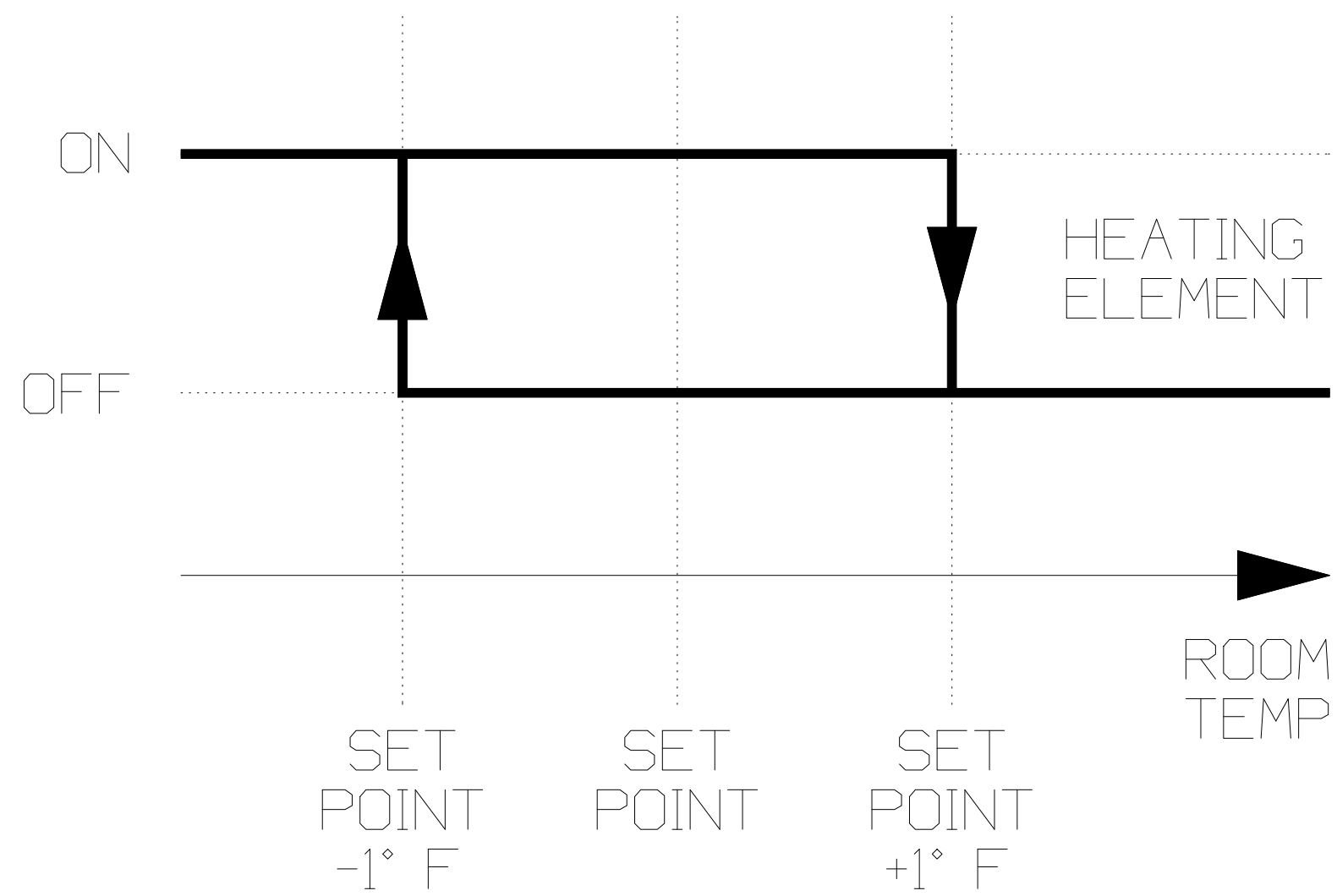

AUTOMATIC FUNCTION MODE CHANGEOVER

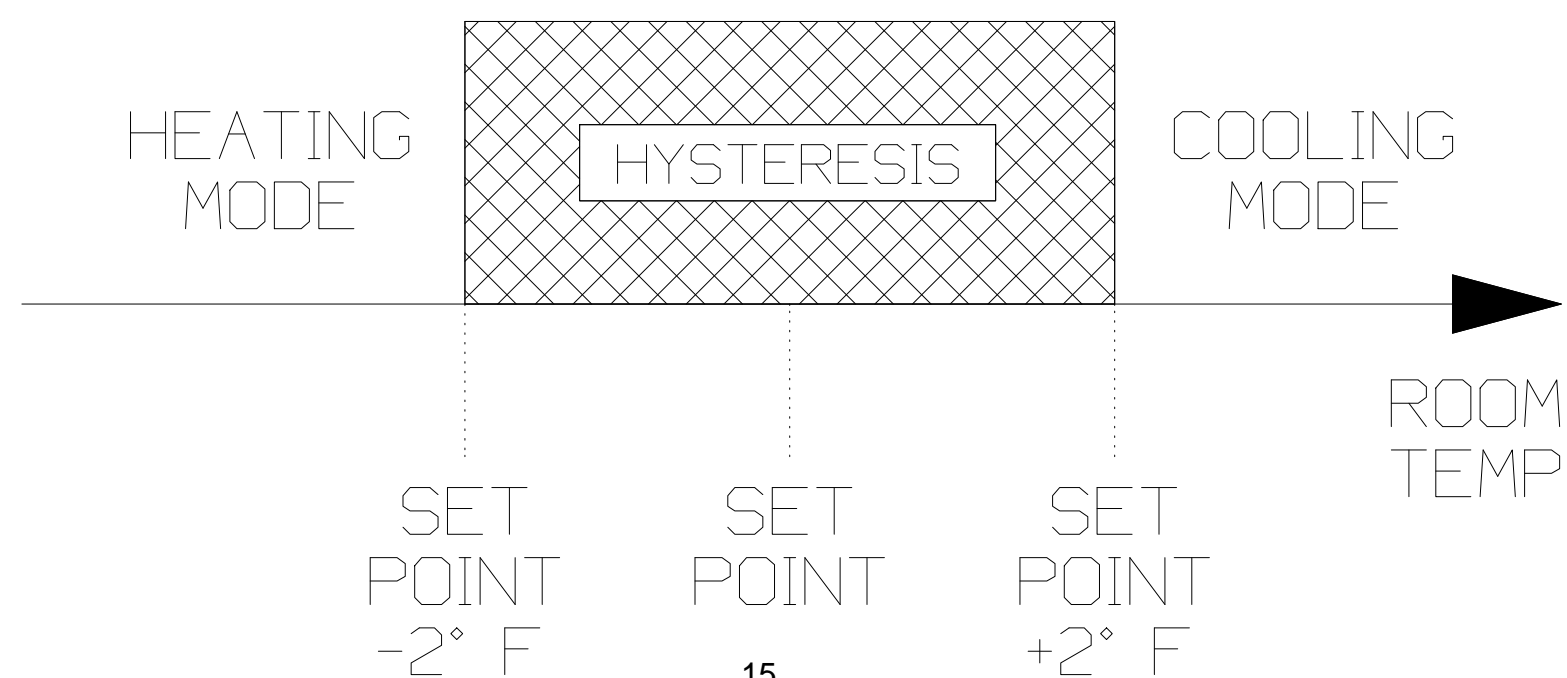

AUTO FAN SPEED OPERATION

COOLING MODE

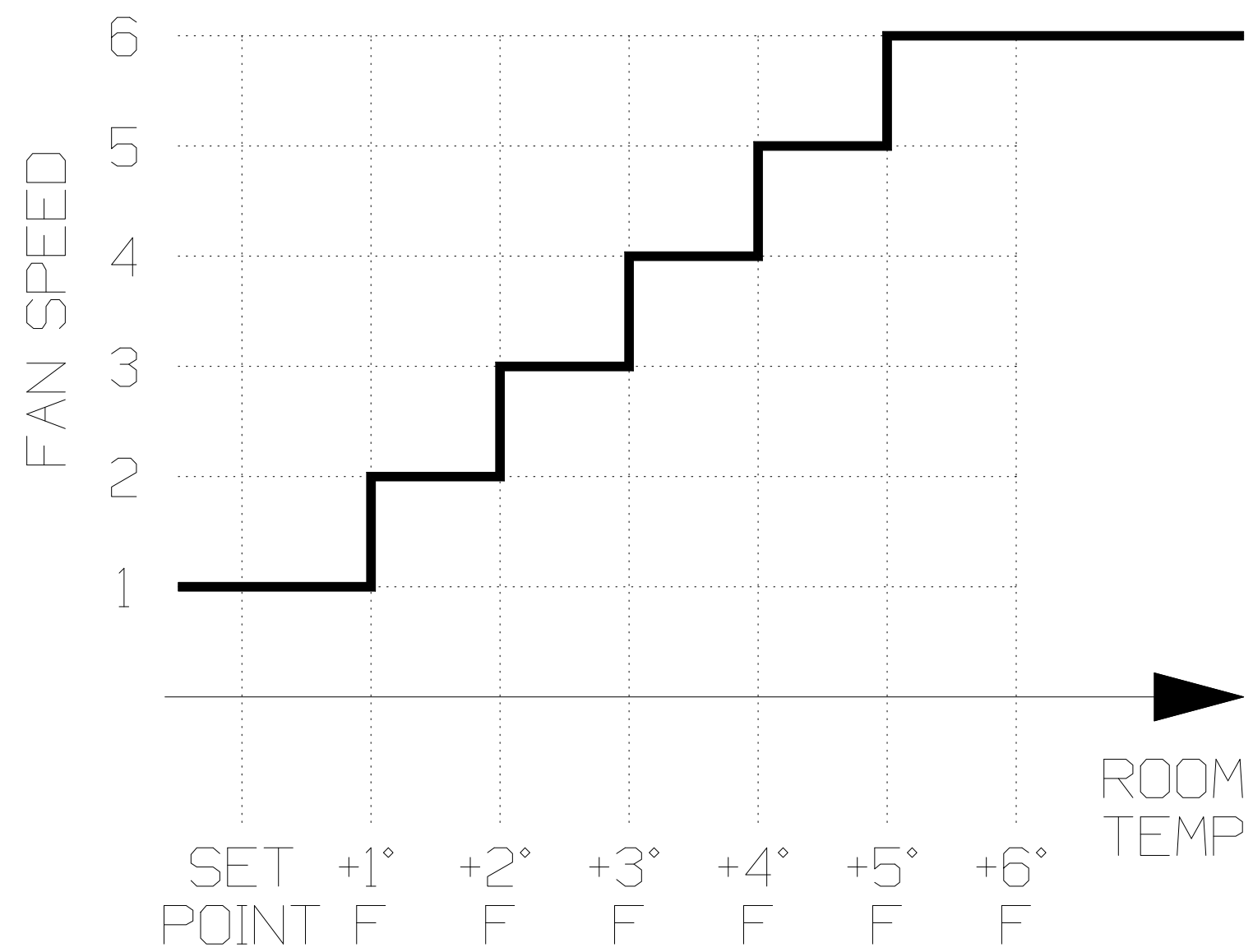

HEATING MODE

PARAMETER A3 = NORMAL (No)

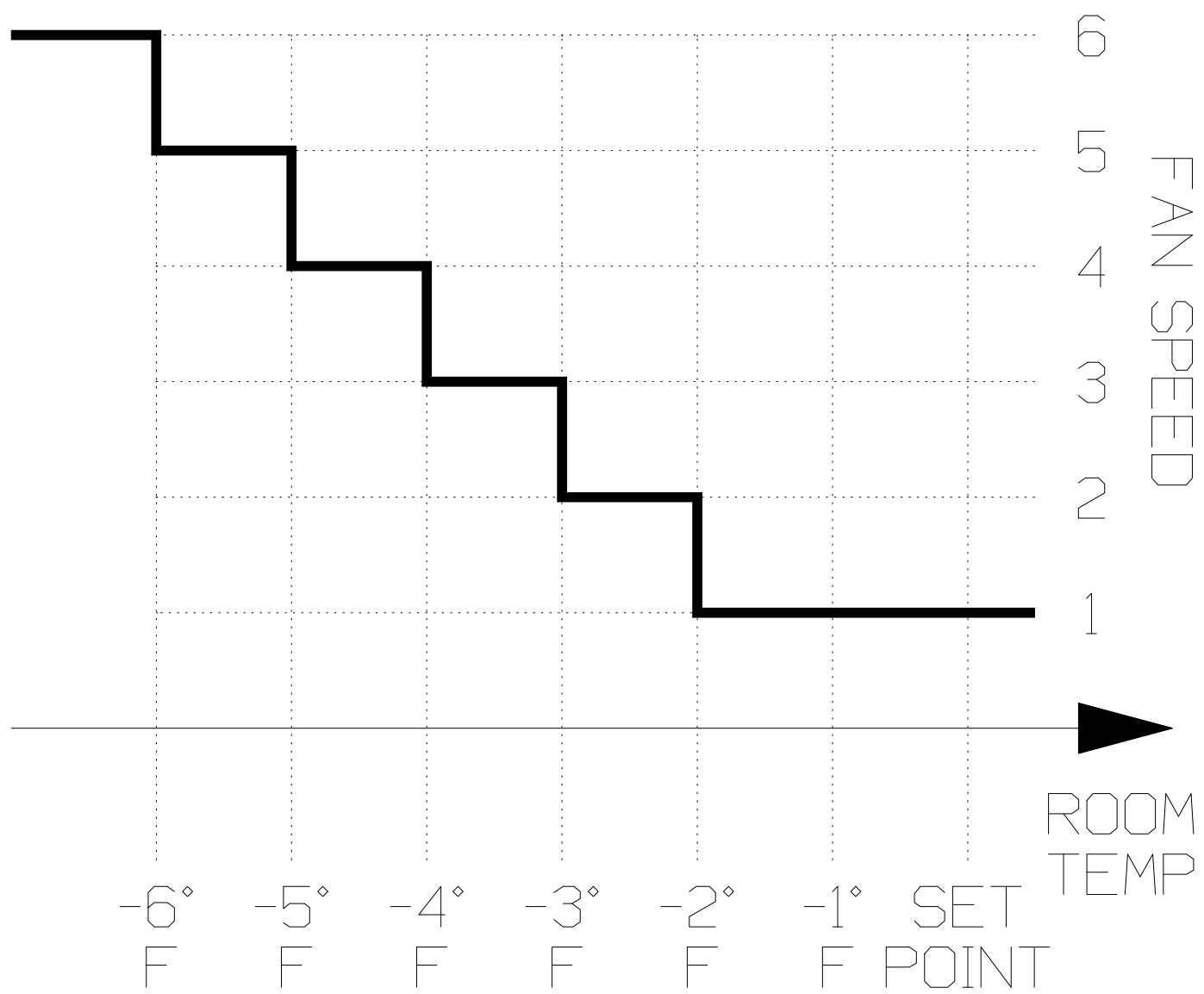

HEATING MODE

PARAMETER A3 = REVERSE (rE)

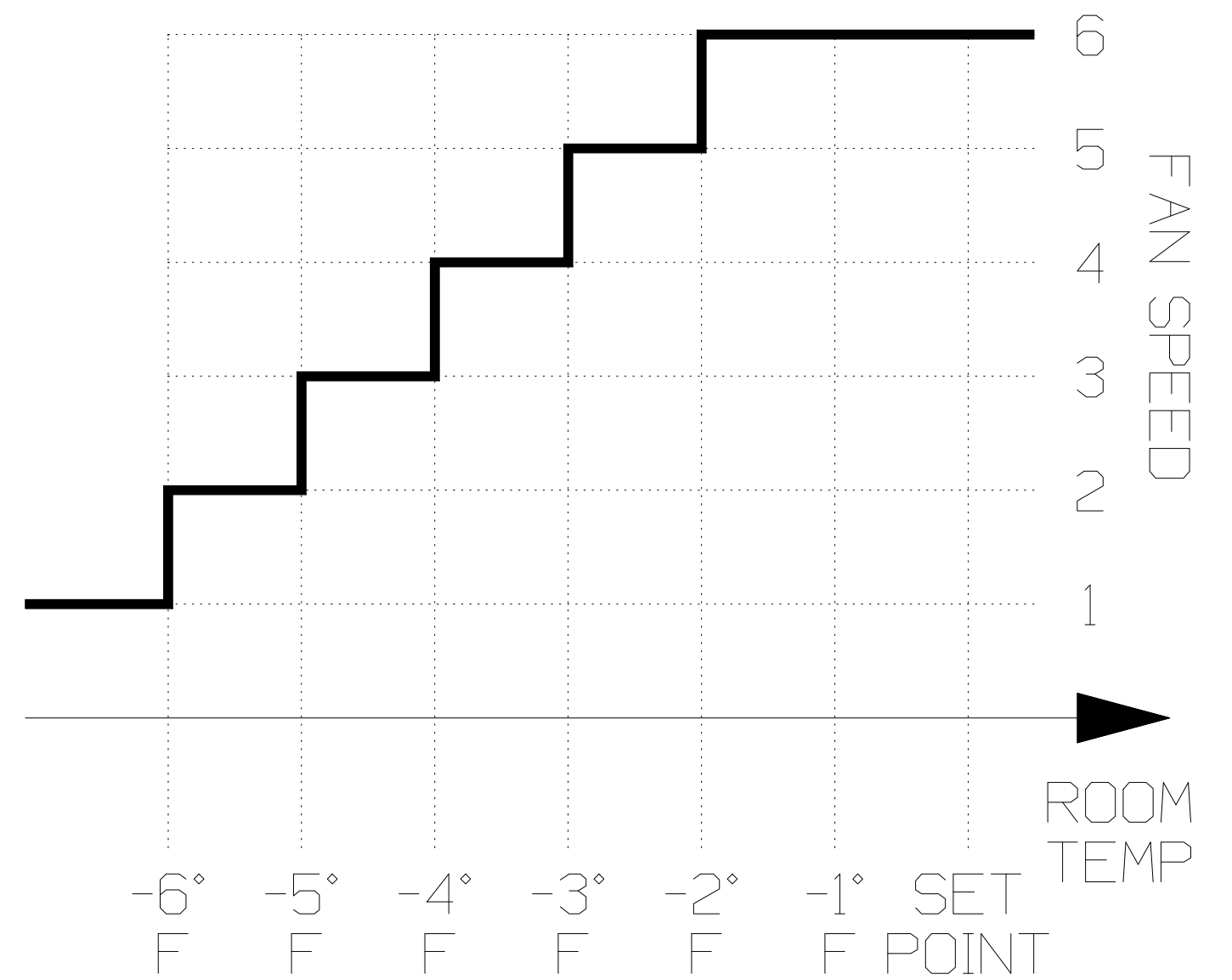

FAN OPERATION & SPEED SELECTION

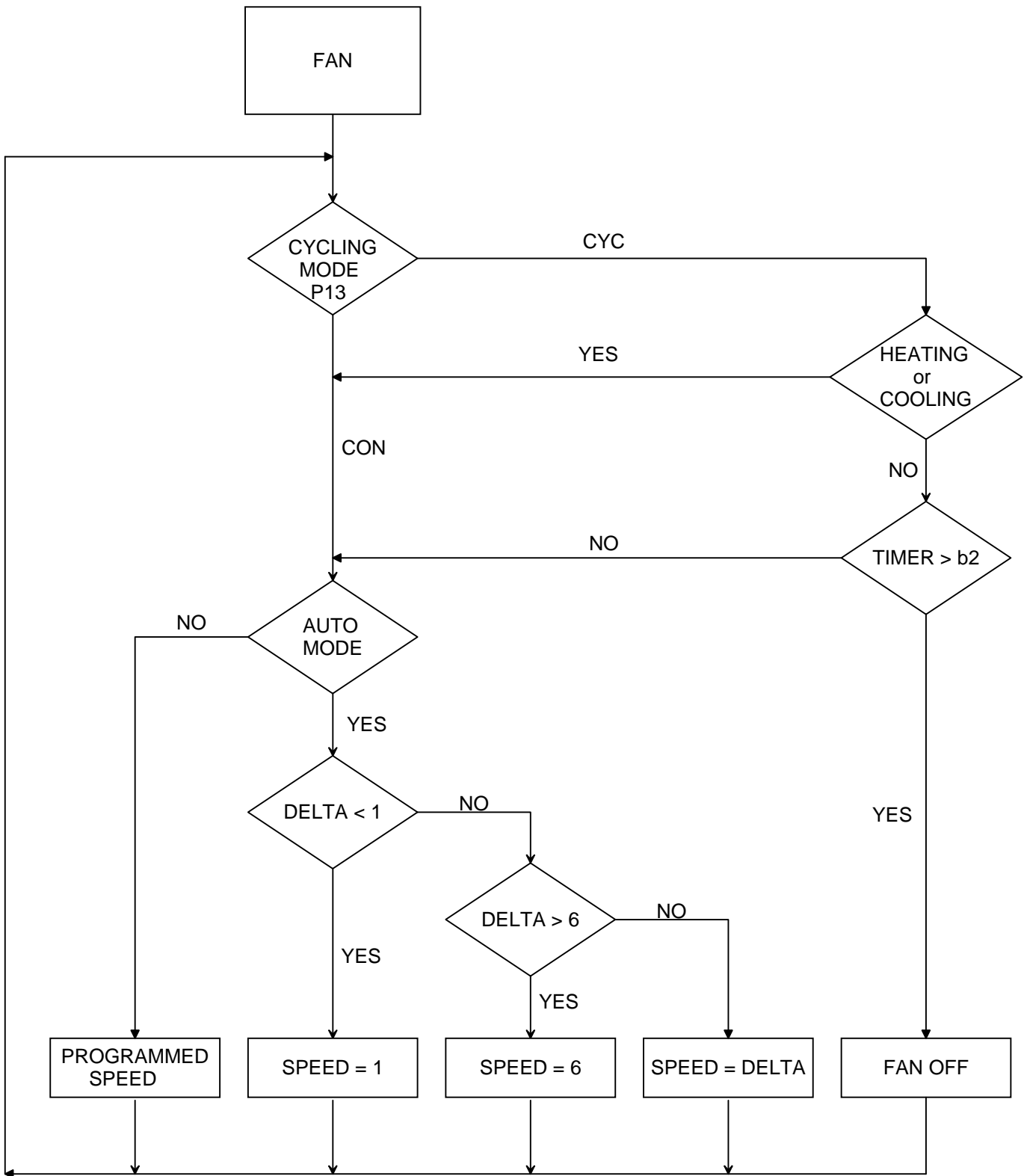

Normal Fan Operation
 $\text{DELTA} = \text{Abs}(T_{\text{air}} - T_{\text{set}})$

Reverse Fan Operation
 $\text{DELTA} = \text{Abs}[\text{Abs}(T_{\text{air}} - T_{\text{set}}) - 6]$

COOLING MODE

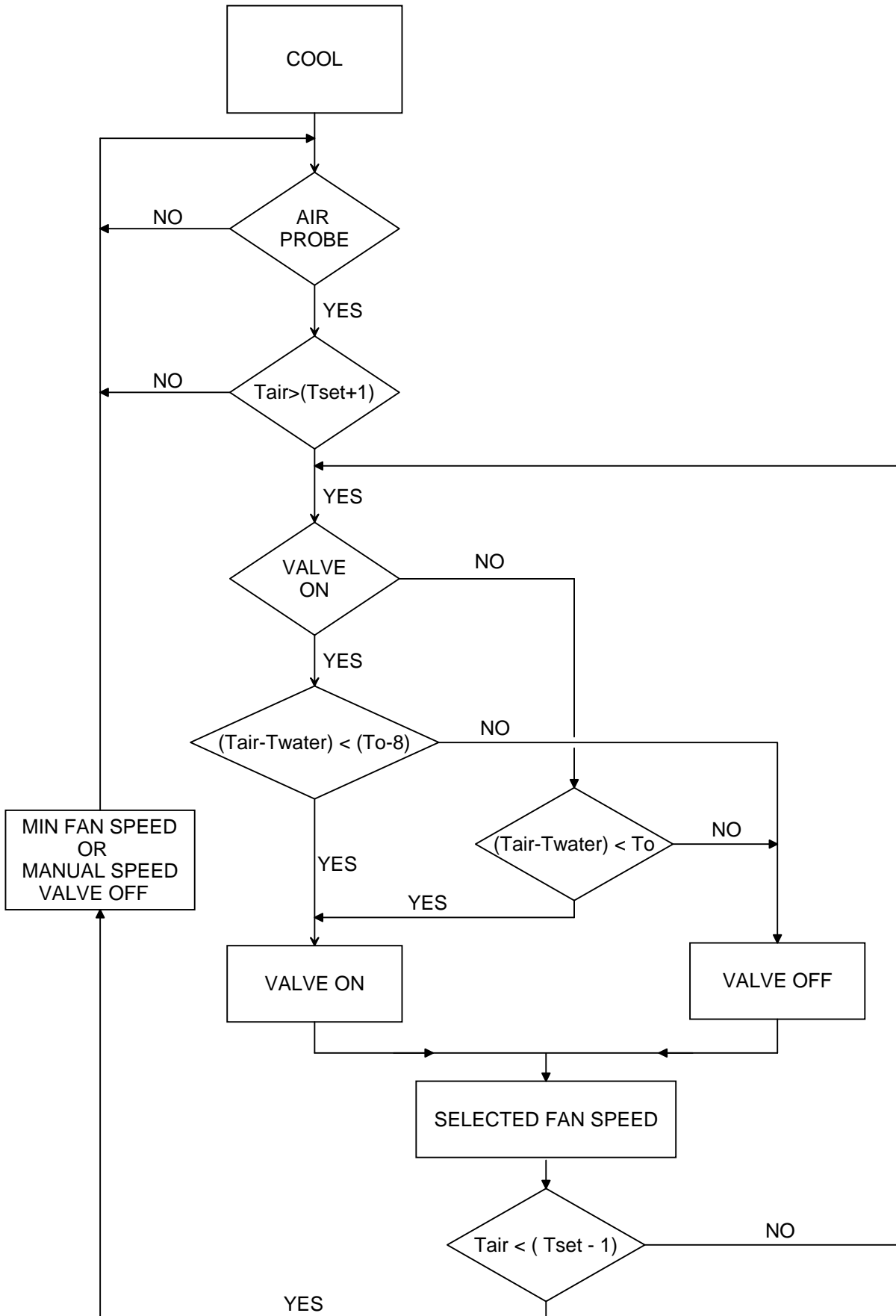

To = Ambient air to Chillwater Temperature Differential A9

HEATING MODE

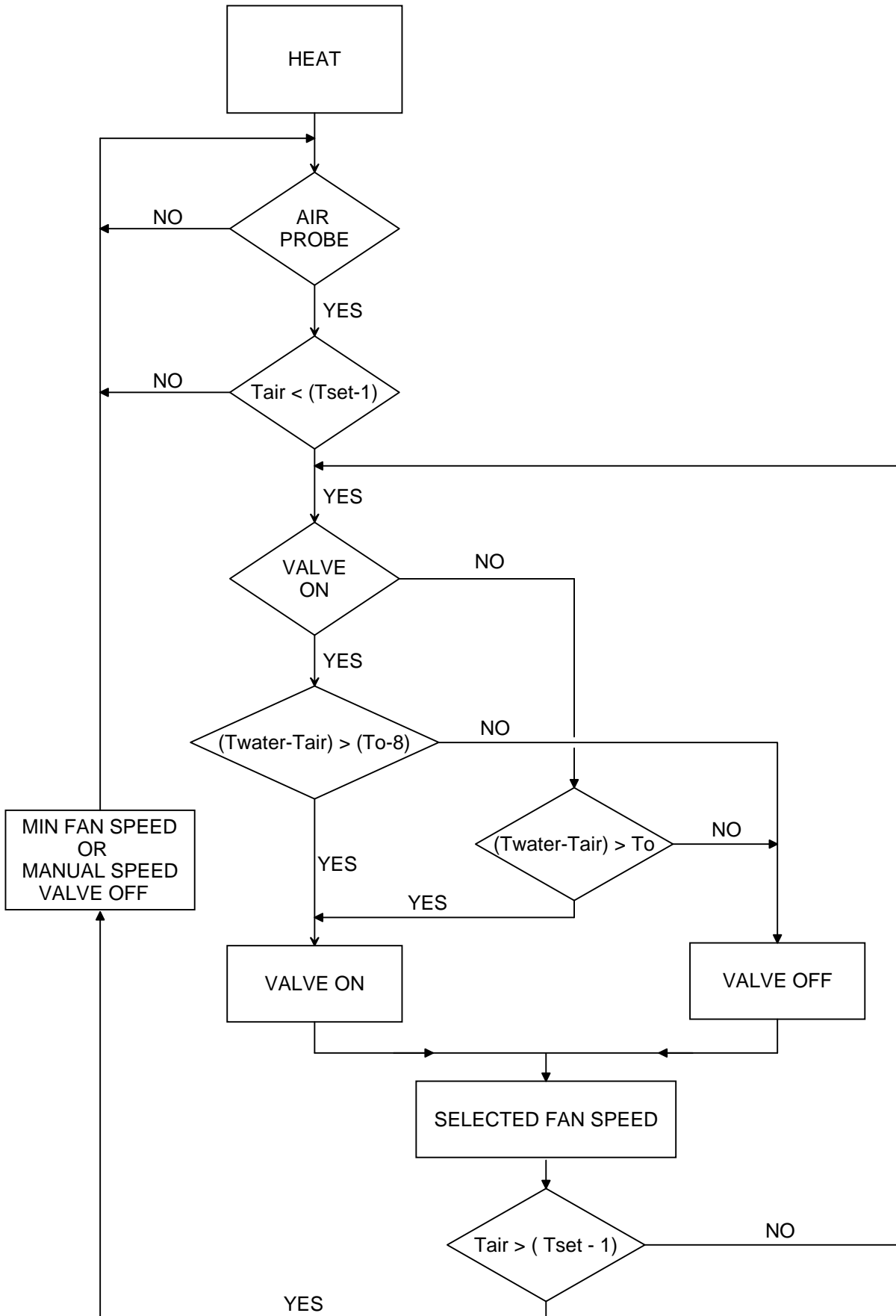

To = Ambient air to Chillwater Temperature Differential A9

ELECTRIC HEATER

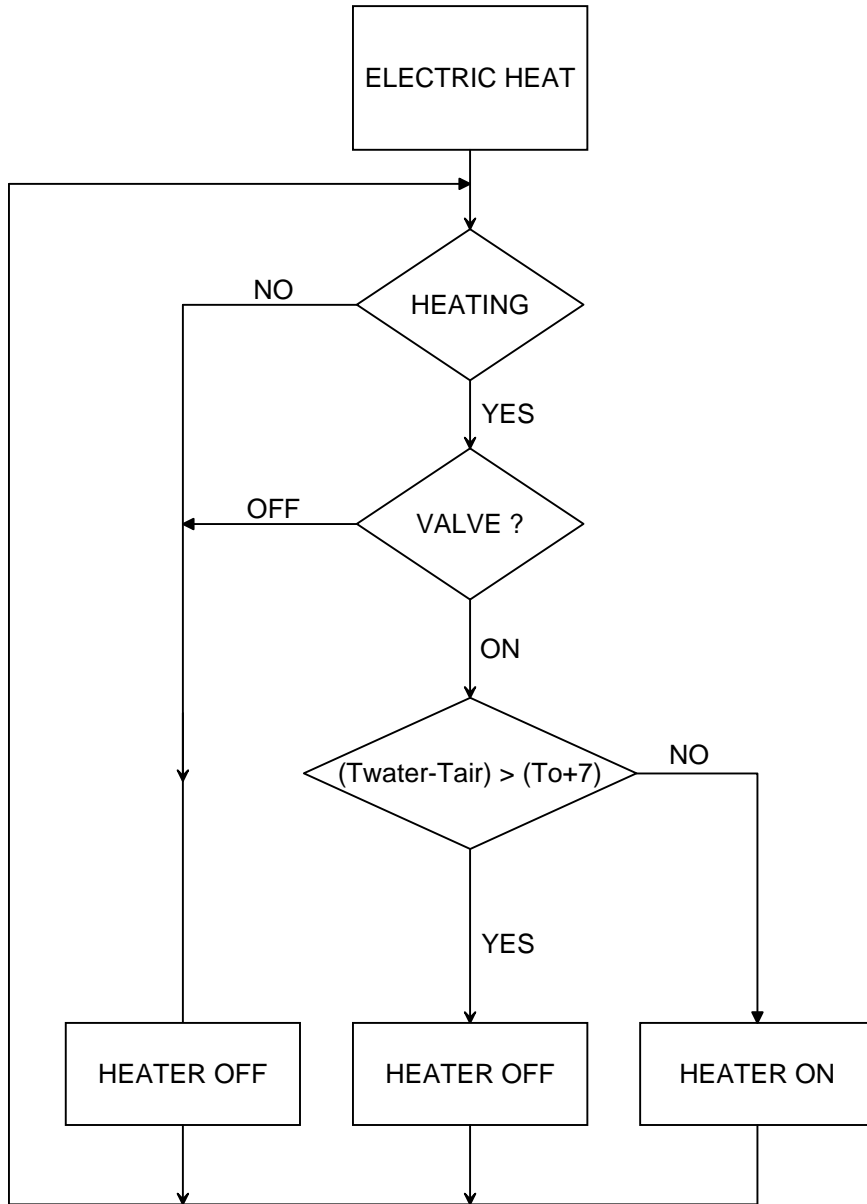

T_o = Ambient air to Chillwater Temperature Differential A9

AUTO MODE

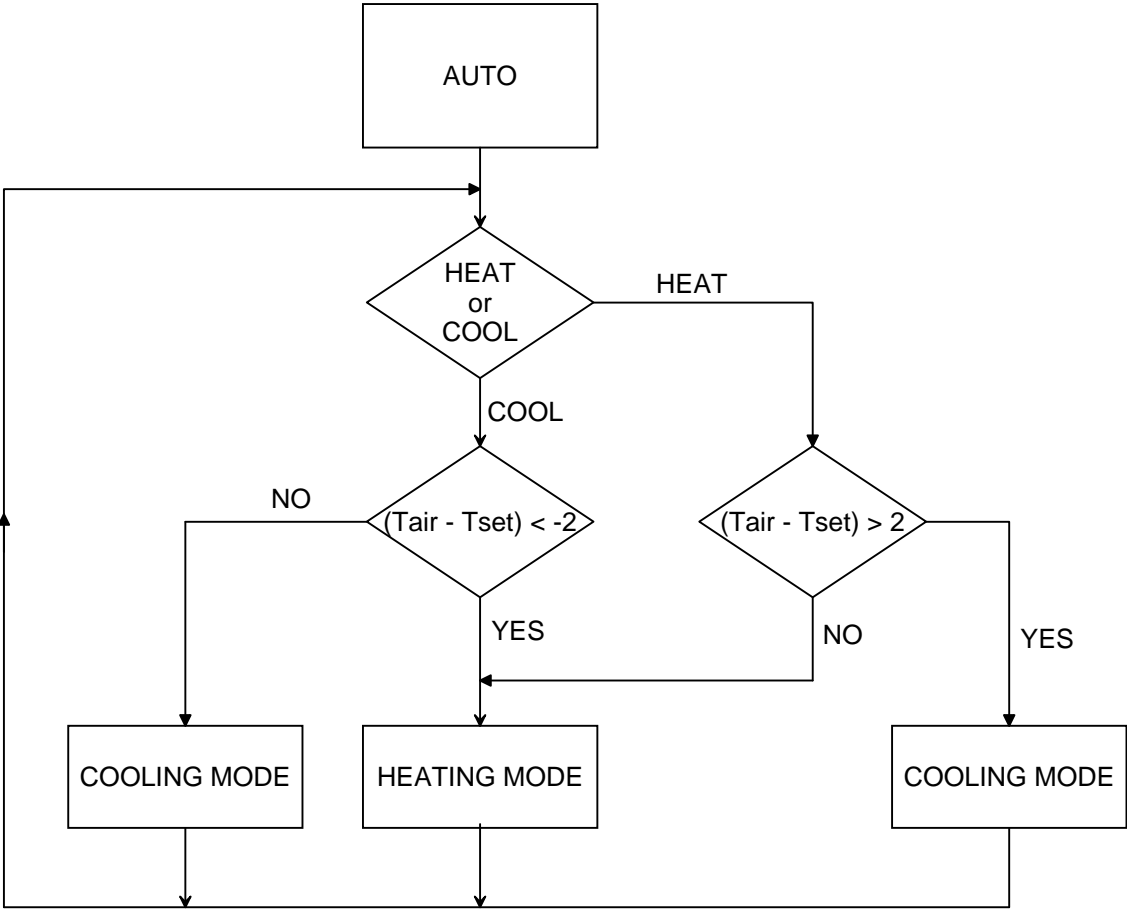

DEHUMIDIFICATION MODE

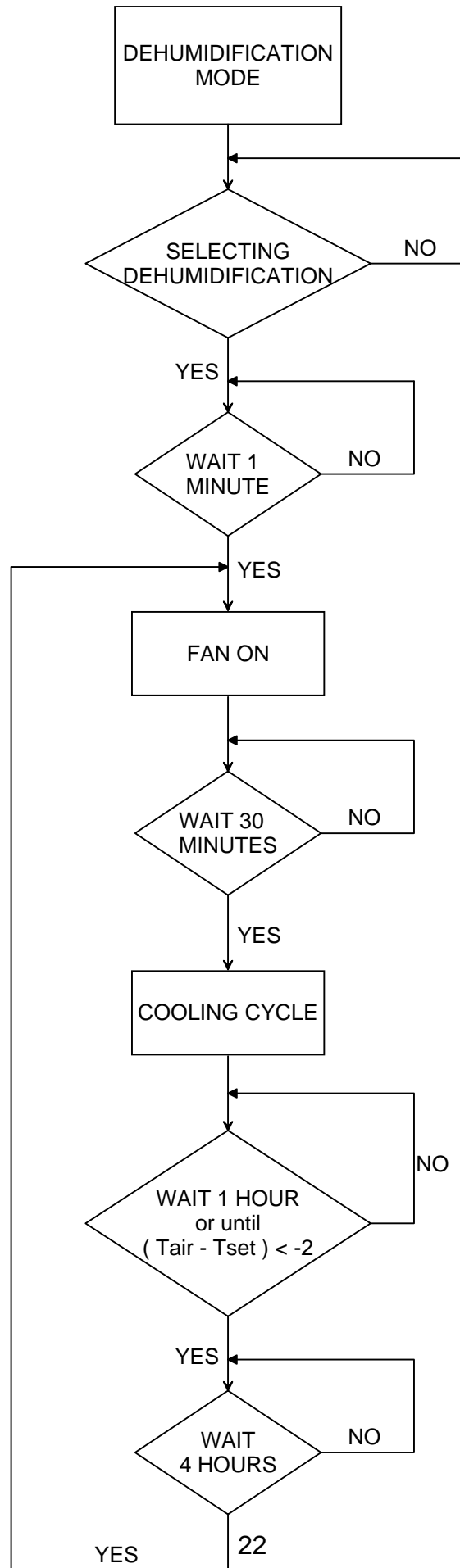

FUSES	
FAN (F2)	25A
TX-PRIM. (F1)	500mA
TX-SEC. (F3)	500mA

INLET WATER SENSOR NOTE
ATTACH SENSOR TO THE WATER INLET LINE AT FAN COIL WATER VALVE

MAXIMUM CIRCUIT RATINGS
WATER VALVE 1/4A
FAN MOTOR 12A
HEATER 20A

- TERMINAL BLOCK CONNECTIONS
1. HEATER ELEMENT L1
 2. HEATER ELEMENT L2
 3. N/A
 4. WATER VALVE L2
 5. WATER VALVE L1
 6. POWER INPUT L1
 7. POWER INPUT L2 or N
 8. FAN L2
 9. FAN L1

NOTE: ALL L2's ARE COMMON TO EACH OTHER

MULTIPLE FAN COILS CAN BE CONNECTED IN PARALLEL TO THE THERMOSTAT PROVIDED THEY DO NOT EXCEED THE MAXIMUM AMPERAGE RATINGS OF THE CONTROL MODULE

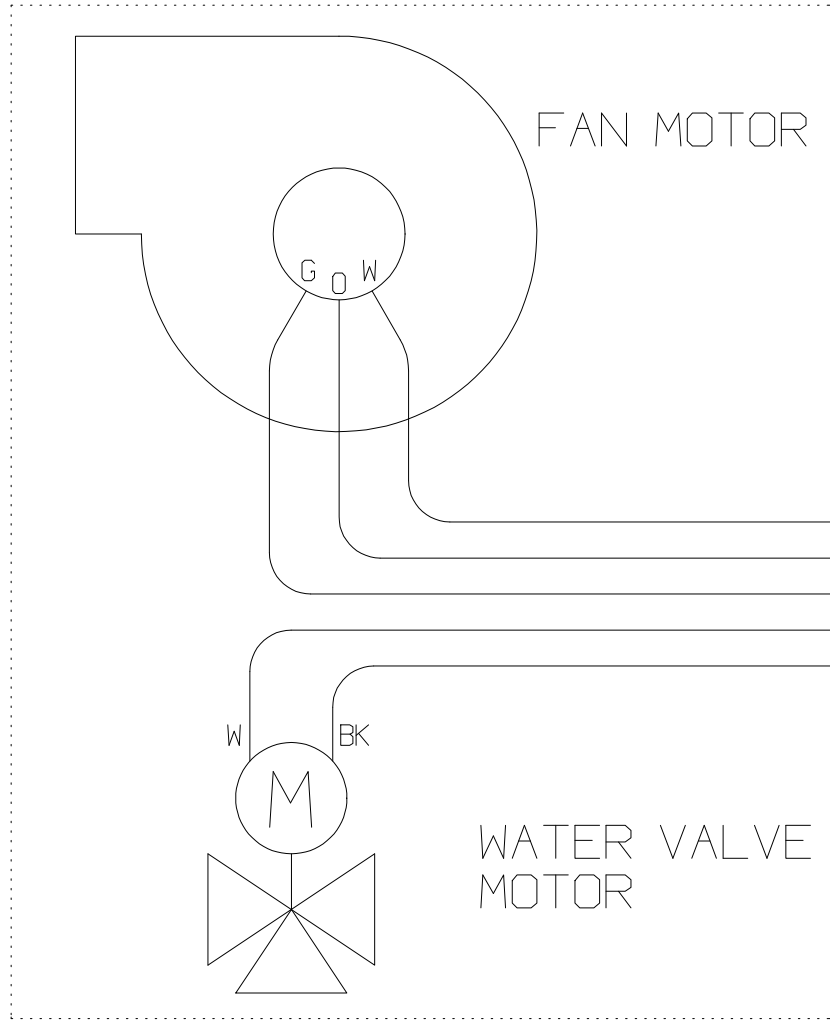

POWER INPUT
115/1/60
200-230/1/50-60
L2 or L1
N
G

NOTE: FAN COIL MOTOR, WATER VALVE & HEATER MUST BE RATED FOR THE SAME VOLTAGE AS THE POWER INPUT.

NOTE: JP1 MUST BE CUT FOR CHILLED WATER APPLICATIONS.

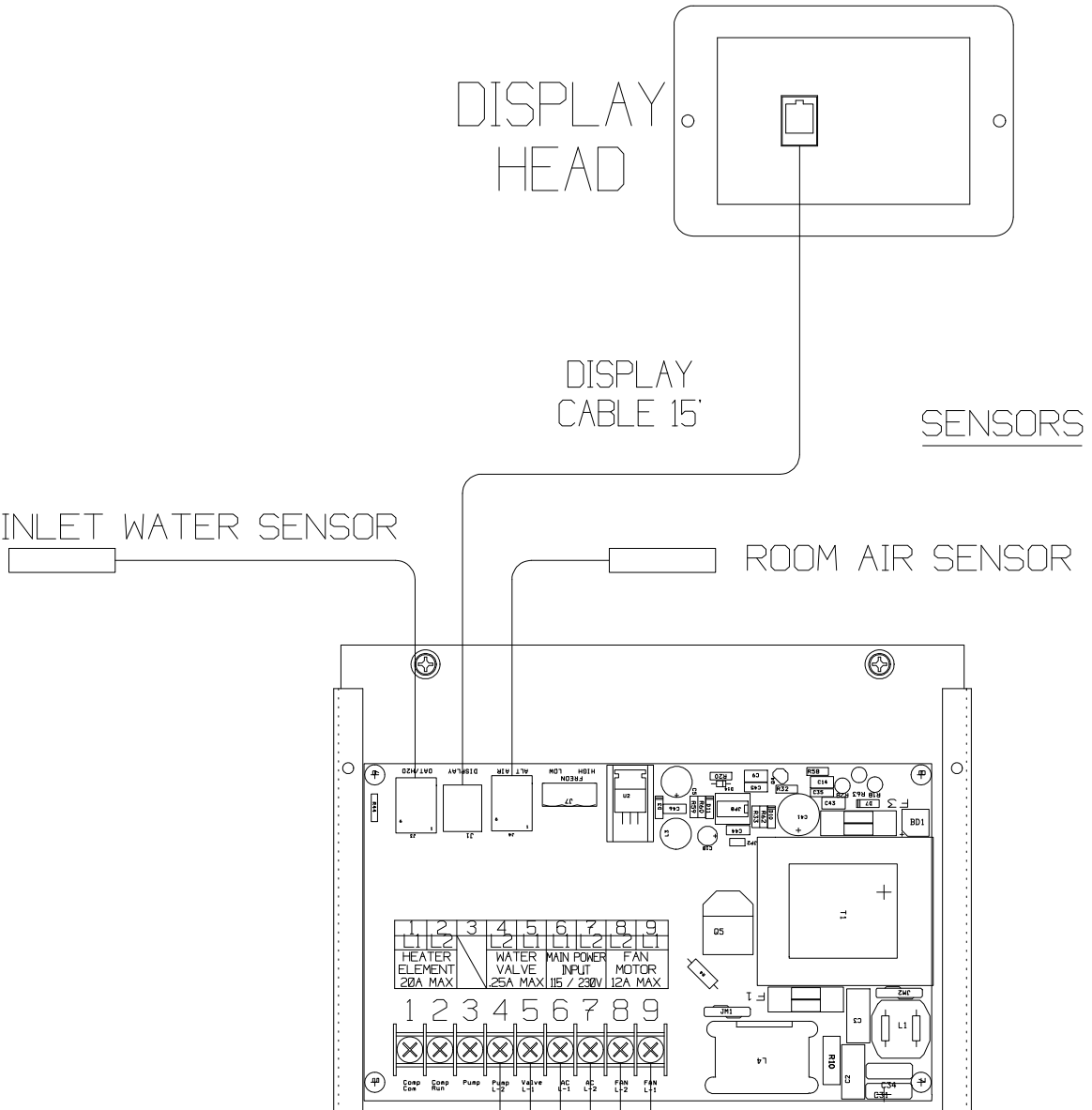

AQUA-AIR MARINE AIR CONDITIONING SYSTEMS

TSVW DIGITAL THERMOSTAT w/ SINGLE AQOW / AQOCW STYLE FAN COIL 115 or 230V COOLING ONLY or with HOT WATER HEAT

DRAWING NUMBER	4011-17A	DRAWN BY	SB	DATE	05-04-05
SCALE	NONE	APPROVED BY	CC	REVISION DATE	
					REV A

FAN COIL 1

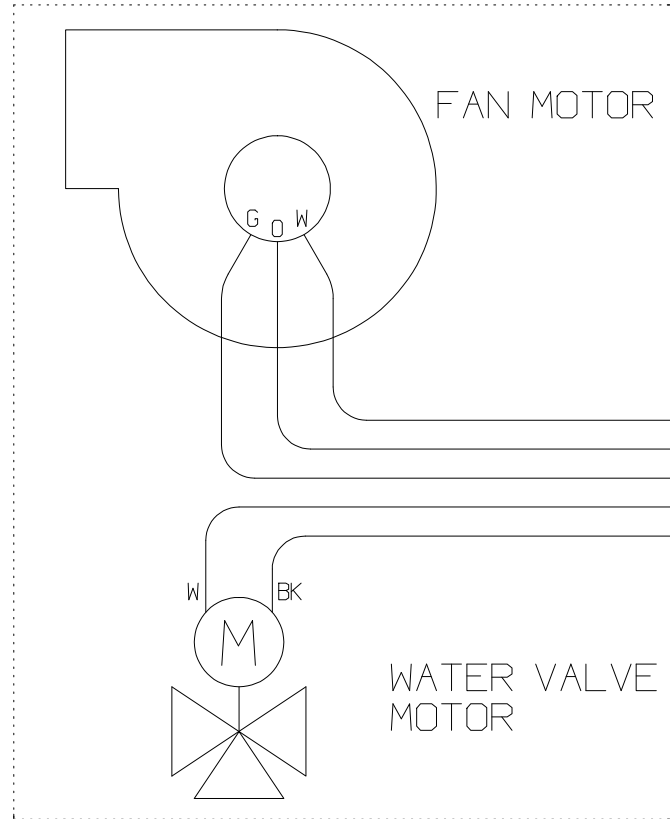

FAN COIL 2

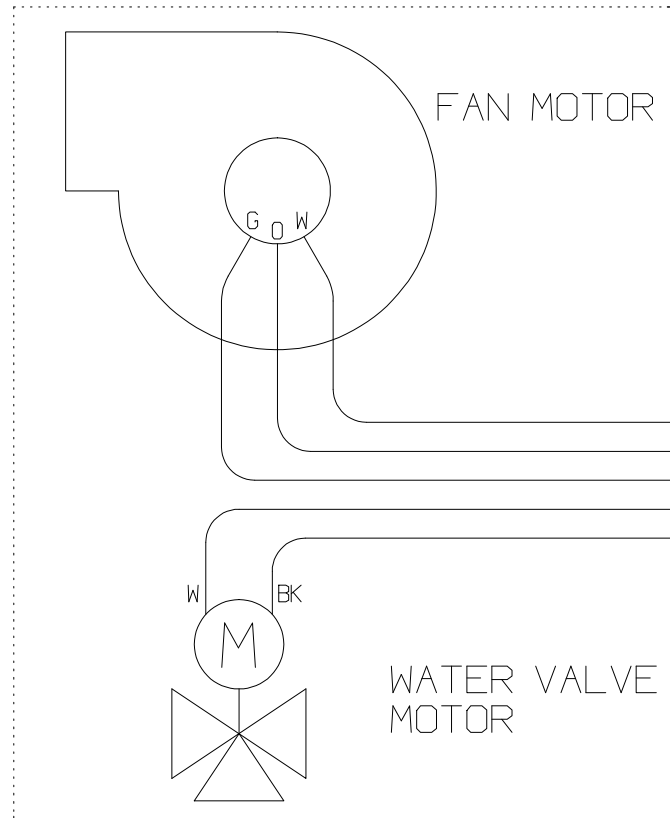

MULTIPLE FAN COILS CAN BE CONNECTED IN PARALLEL TO THE THERMOSTAT PROVIDED THEY DO NOT EXCEED THE MAXIMUM AMPERAGE RATINGS OF THE CONTROL MODULE

FUSES	
FAN (F2)	25A
TX-PRIM. (F1)	500mA
TX-SEC. (F3)	500mA

INLET WATER SENSOR NOTE
ATTACH SENSOR TO THE WATER INLET LINE AT FAN COIL WATER VALVE

MAXIMUM CIRCUIT RATINGS
WATER VALVE 1/4A
FAN MOTOR 12A
HEATER 20A

TERMINAL BLOCK CONNECTIONS

1. HEATER ELEMENT L1
2. HEATER ELEMENT L2
3. N/A
4. WATER VALVE L2
5. WATER VALVE L1
6. POWER INPUT L1
7. POWER INPUT L2 or N
8. FAN L2
9. FAN L1

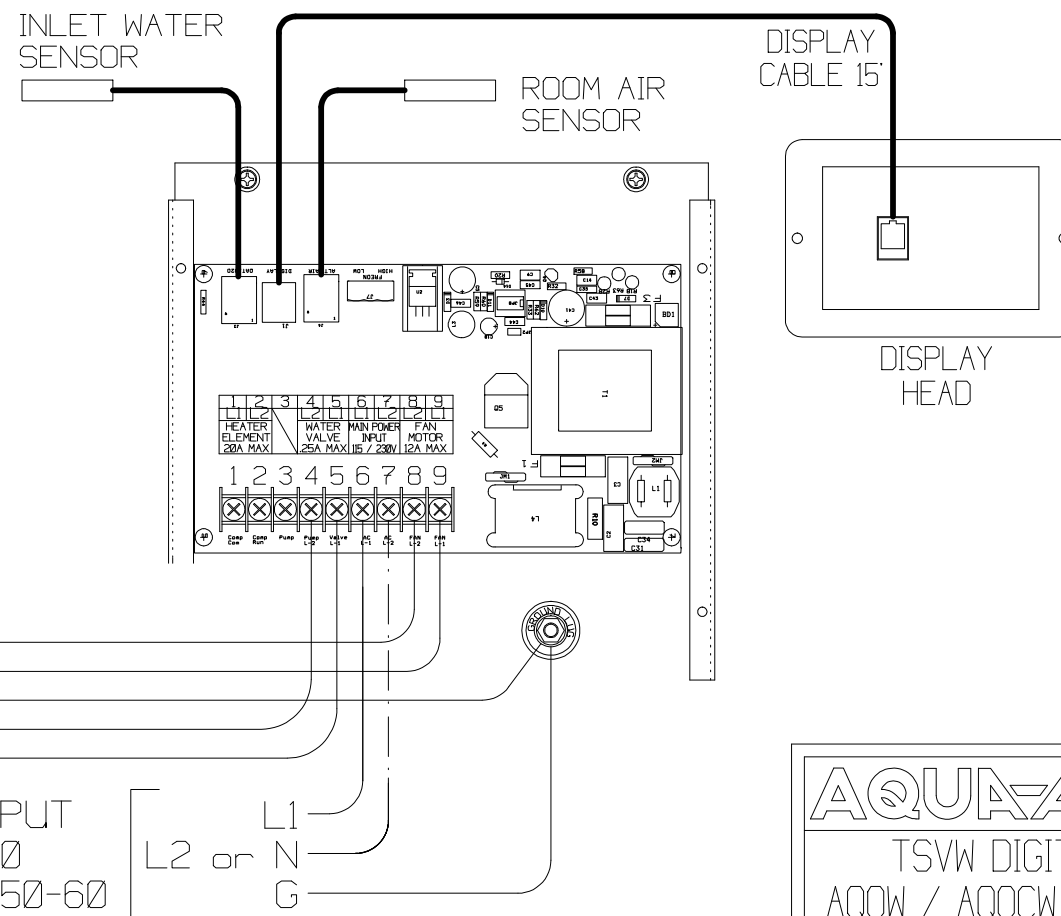

POWER INPUT
115/1/60 [L1
200-230/1/50-60 [L2 or N
G

NOTE: FAN COIL MOTOR & WATER VALVE MUST BE RATED FOR THE SAME VOLTAGE AS THE POWER INPUT.

AQUA-AIR MARINE AIR CONDITIONING SYSTEMS

TSVW DIGITAL THERMOSTAT w/ TWO AQOW / AQOCW STYLE FAN COILS 115 or 230V COOLING ONLY or with HOT WATER HEAT

DRAWING NUMBER	4011-29	DRAWN BY	SB	DATE	08-15-05
SCALE	NONE	APPROVED BY	CC	REVISION DATE	
					REV A

DUCT HEATER (DH SERIES) or
FAN COIL HEATER (BH SERIES)

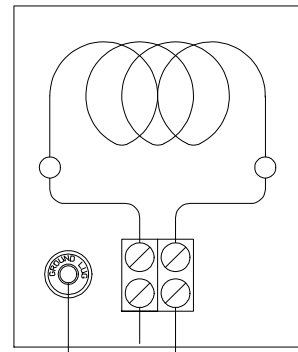

MULTIPLE FAN COILS
CAN BE
CONNECTED IN PARALLEL
TO THE THERMOSTAT
PROVIDED THEY DO NOT
EXCEED THE MAXIMUM
AMPERAGE RATINGS OF
THE CONTROL MODULE

DISPLAY
HEAD

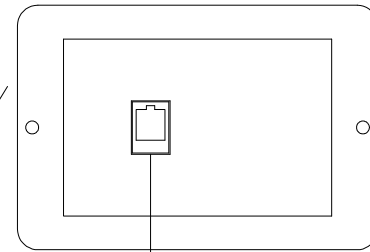

DISPLAY
CABLE 15'

SENSORS

FUSES	
FAN (F2)	25A
TX-PRIM. (F1)	500mA
TX-SEC. (F3)	500mA

INLET WATER SENSOR NOTE
ATTACH SENSOR TO THE
WATER INLET LINE AT
FAN COIL WATER VALVE

MAXIMUM CIRCUIT RATINGS
WATER VALVE 1/4A
FAN MOTOR 12A
HEATER 20A

TERMINAL BLOCK CONNECTIONS

1. HEATER ELEMENT L1
2. HEATER ELEMENT L2
3. N/A
4. WATER VALVE L2
5. WATER VALVE L1
6. POWER INPUT L1
7. POWER INPUT L2 or N
8. FAN L2
9. FAN L1

INLET WATER SENSOR

ROOM AIR SENSOR

1	2	3	4	5	6	7	8	9
HEATER ELEMENT 20A MAX	L2	L1	WATER VALVE	MAIN INPUT	POWER INPUT	FAN MOTOR		

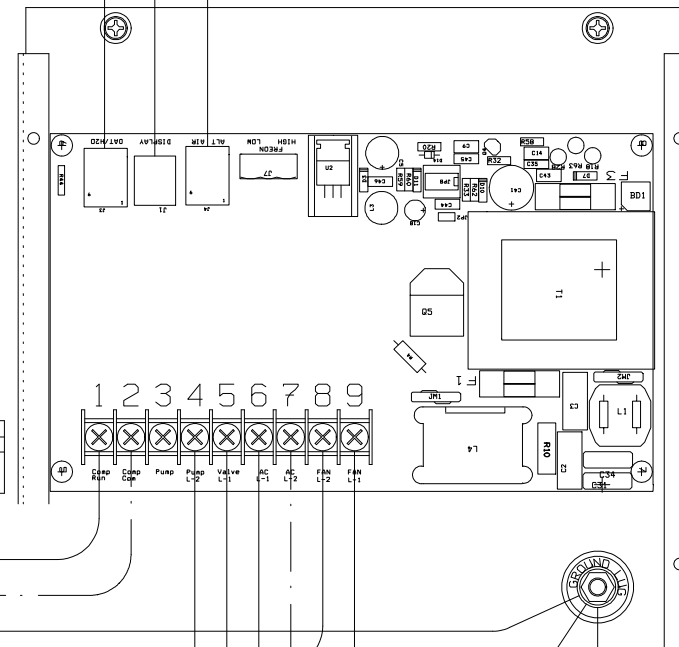

FAN MOTOR

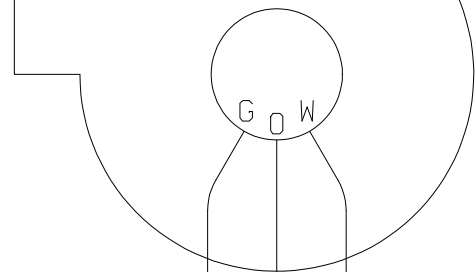

WATER VALVE
MOTOR

FAN COIL

POWER INPUT
115/1/60
200-230/1/50-60

L1
L2 or N
G

NOTE: FAN COIL MOTOR, WATER VALVE & HEATER MUST BE
RATED FOR THE SAME VOLTAGE AS THE POWER INPUT.

NOTE: JP1 MUST BE CUT FOR CHILLED WATER APPLICATIONS.

CHECK HEATER AMP RATING. IF AMP DRAW
EXCEEDS HTR CIRCUIT RATING AN OPTIONAL
HTR RELAY BOX WILL NEED TO BE USED.

AQUA-AIR MARINE AIR CONDITIONING
SYSTEMS

TSVW DIGITAL THERMOSTAT w/ SINGLE
AQOW/AQOCW STYLE FAN COIL UNIT AND
ELECTRIC HEAT - 115/230V 50/60 Hz

DRAWING NUMBER	4011-18	DRAWN BY	SB	DATE	05-04-05
SCALE	NONE	APPROVED BY	CC	REVISION DATE	
					REV A

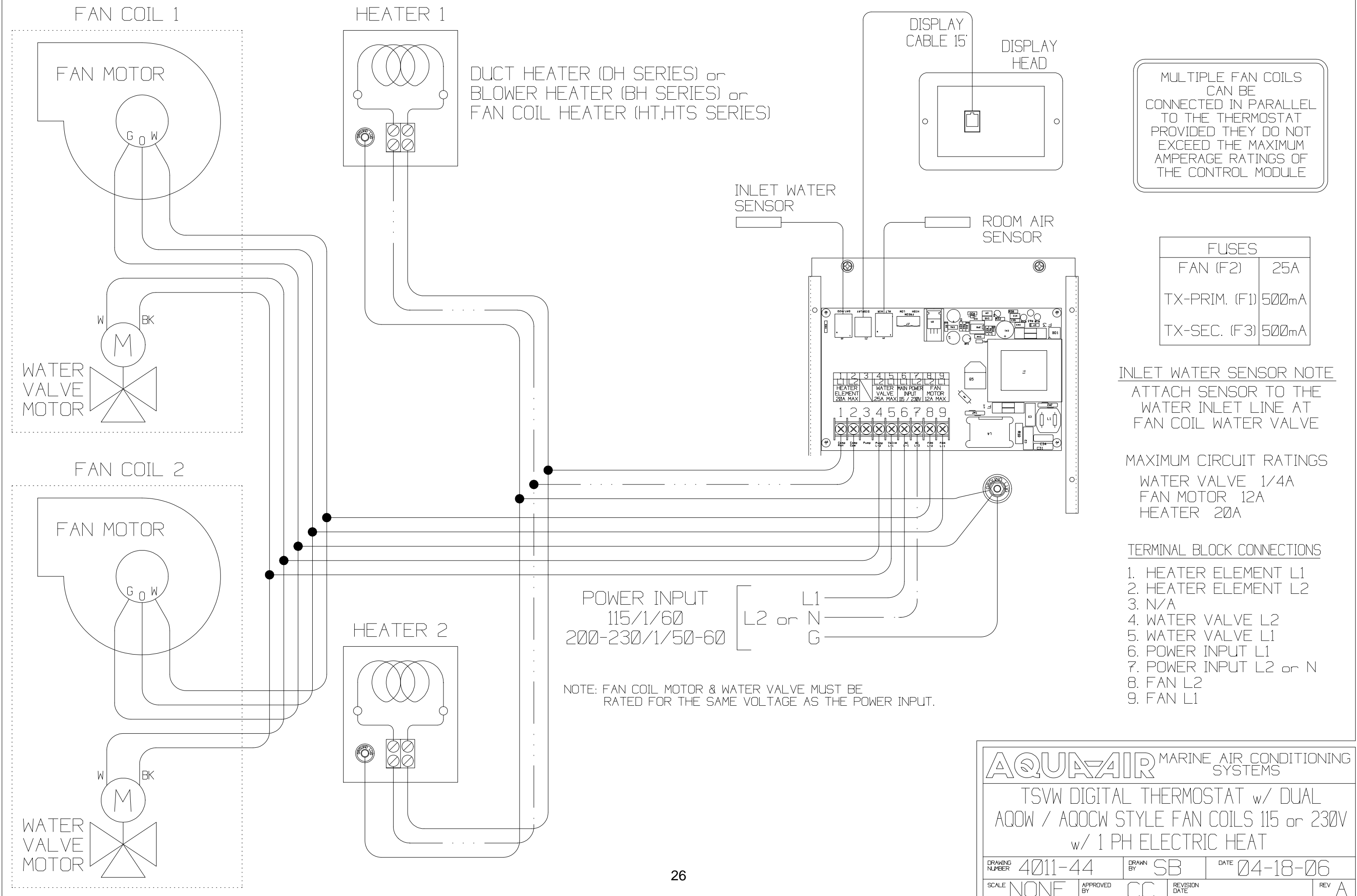

MULTIPLE FAN COILS CAN BE CONNECTED IN PARALLEL TO THE THERMOSTAT PROVIDED THEY DO NOT EXCEED THE MAXIMUM AMPERAGE RATINGS OF THE CONTROL MODULE

FUSES	
FAN (F2)	25A
TX-PRIM. (F1)	500mA
TX-SEC. (F3)	500mA

INLET WATER SENSOR NOTE
ATTACH SENSOR TO THE WATER INLET LINE AT FAN COIL WATER VALVE

MAXIMUM CIRCUIT RATINGS
WATER VALVE 1/4A
FAN MOTOR 12A
HEATER 20A

- TERMINAL BLOCK CONNECTIONS
1. HEATER ELEMENT L1
 2. HEATER ELEMENT L2
 3. N/A
 4. WATER VALVE L2
 5. WATER VALVE L1
 6. POWER INPUT L1
 7. POWER INPUT L2 or N
 8. FAN L2
 9. FAN L1

AQUA-AIR MARINE AIR CONDITIONING SYSTEMS

TSWV DIGITAL THERMOSTAT w/ DUAL AQOW / AQOCW STYLE FAN COILS 115 or 230V w/ 1 PH ELECTRIC HEAT

DRAWING NUMBER	4011-44	DRAWN BY	SB	DATE	04-18-06
SCALE	NONE	APPROVED BY	CC	REVISION DATE	
					REV
					A

TSVW COMPONENT DIMENSIONS

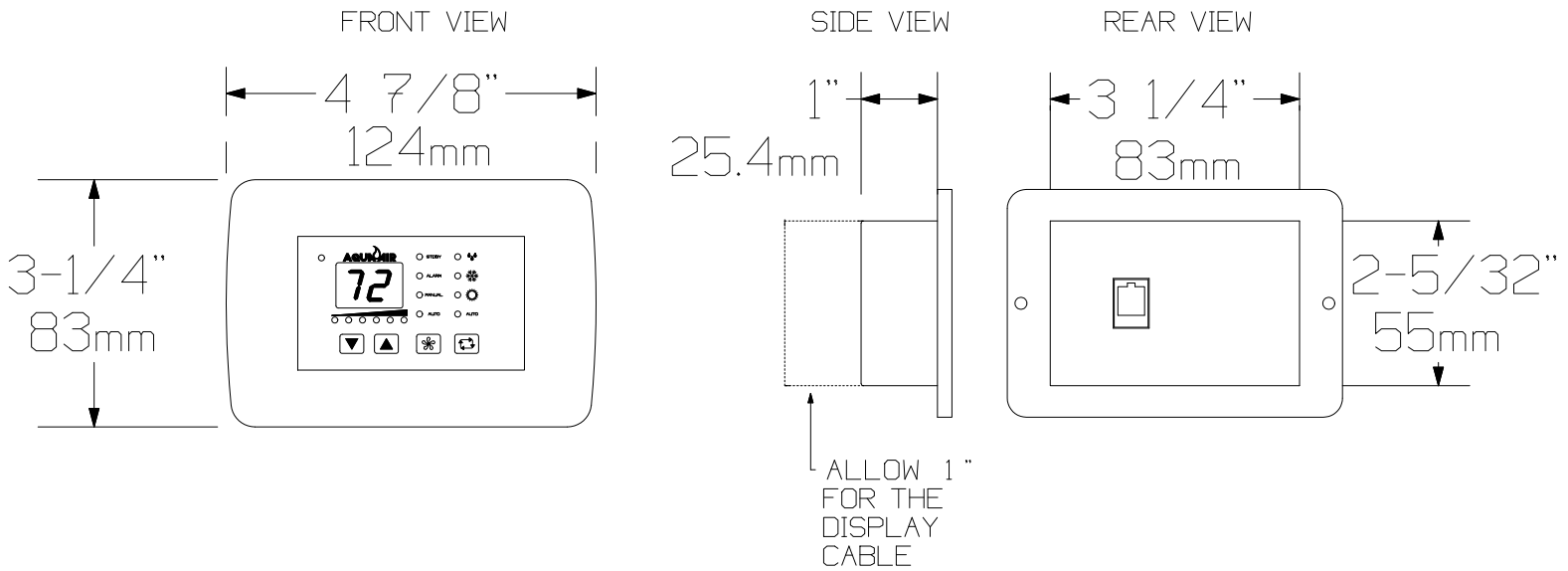

TSV-01 DISPLAY

TSVW-02 CONTROL MODULE

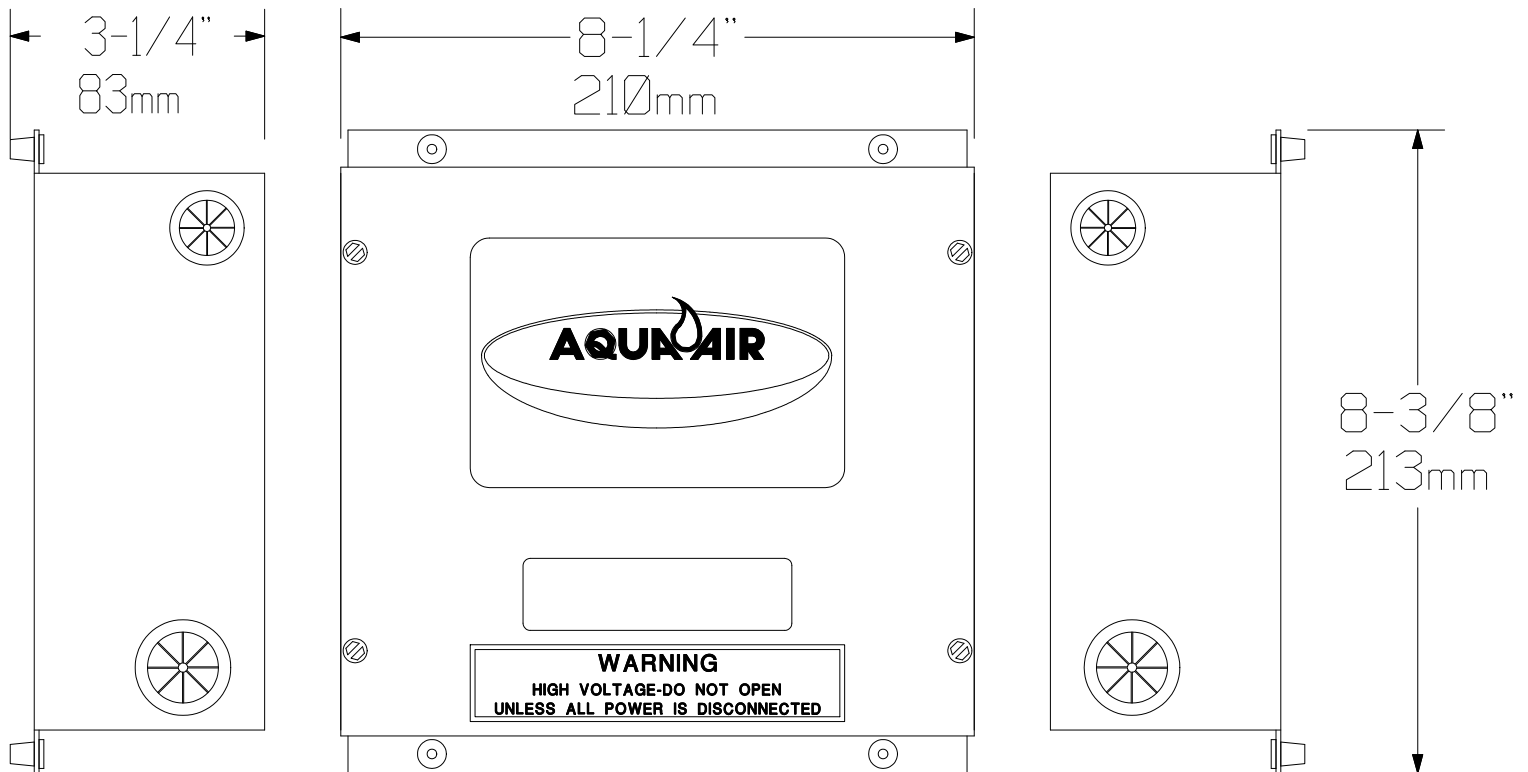

TWWS DIGITAL THERMOSTAT COMPONENT DIMENSIONS

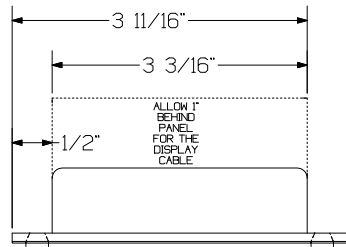

TWWS-01 DISPLAY HEAD

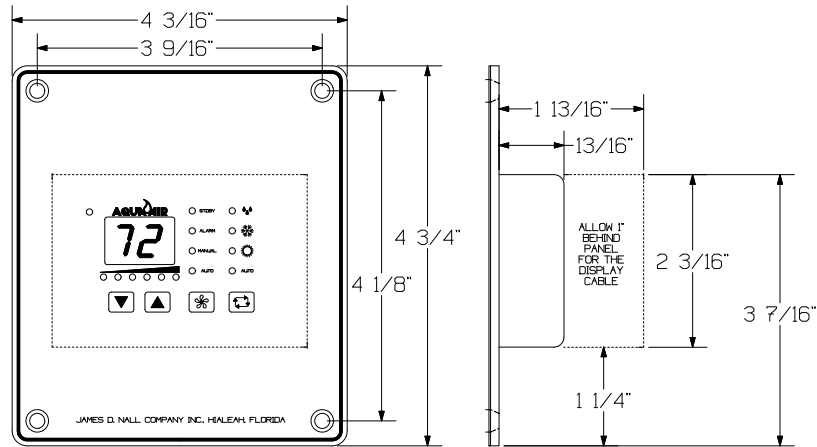

TSVW-02 CONTROL MODULE

